

CAR GSM Antenna

MODEL: MA-83A



1. GENERAL DESCRIPTION

Model No	P/N
	MA-83A

Below is a table summarizing the antenna design specification.

1.1 Electrical Properties



Parameter	Description
Frequency Band	850/900/1800/1900/2100MHz
Nominal Impedance	50 ohm
Polarization	Vertical
Electrical Wave	1 / 2 λ Dipole
Return Loss	Please See Data-1
V.S.W.R	2.0 : 1
Antenna Average Gain	0~3 dBi
Note: Gain includes the cable loss	

1.2 Mechanical Properties

Parameter	Description
Antenna Type	External Antenna

Touch Type	Magnet Type
Connector Type	SMA 180°(Male)
Antenna Dimensions	58.3±5 & 197.5±5
Antenna Cable Total Length	RG-174 A/U 3000 mm ±30
Antenna Color	Black
Operating Temperature Range	-40°C~+85°C
Storage Temperature Range	-40°C~+85°C

1. Appearance

 Third angle projection		CUSTOMER'S	MODEL	PARTS NUMBER	FREQUENCY	UNIT	SCALE	DATE	VERSION
		TOLERANCE	1 X X40.15	NAME	900/180MHz	V/M			20101201
SURFACE ROUGHNESS				APPEARANCE					

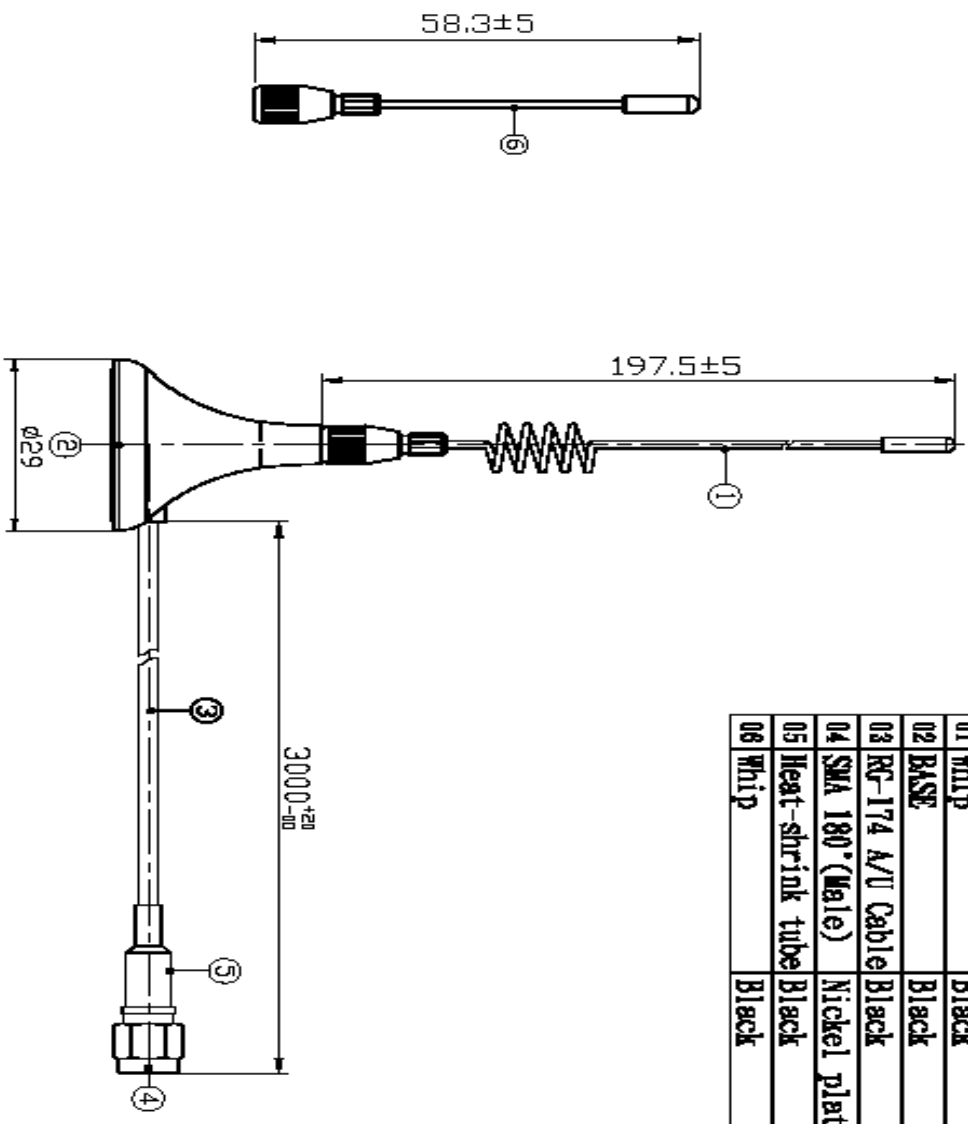

NO.	NAME	FINISH	QTY
01	Whip	Black	01
02	BASE	Black	01
03	RG-174 A/U Cable	Black	01
04	SMA 180° (Male)	Nickel plating	01
05	Heat-shrink tube	Black	01
06	Whip	Black	01

2. Frequency

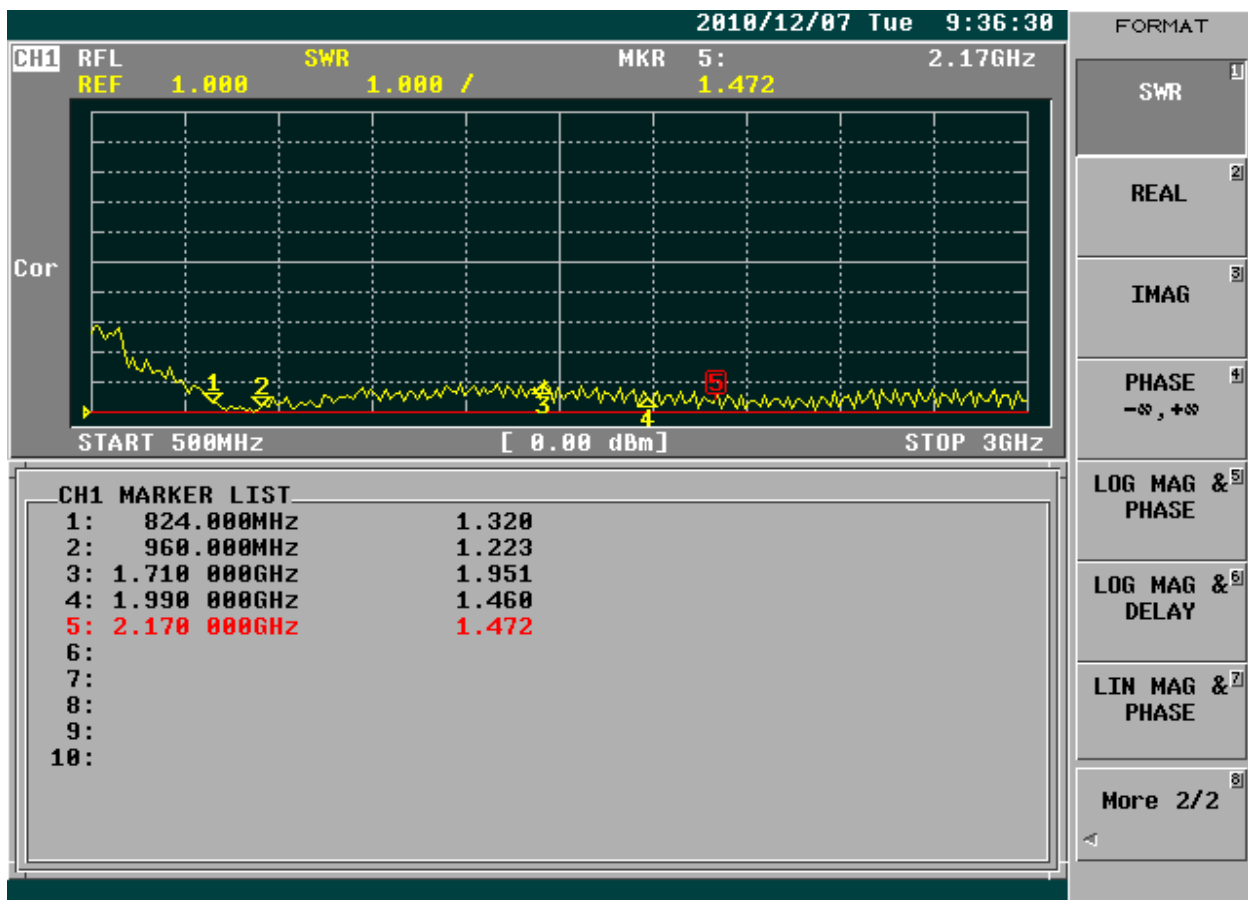
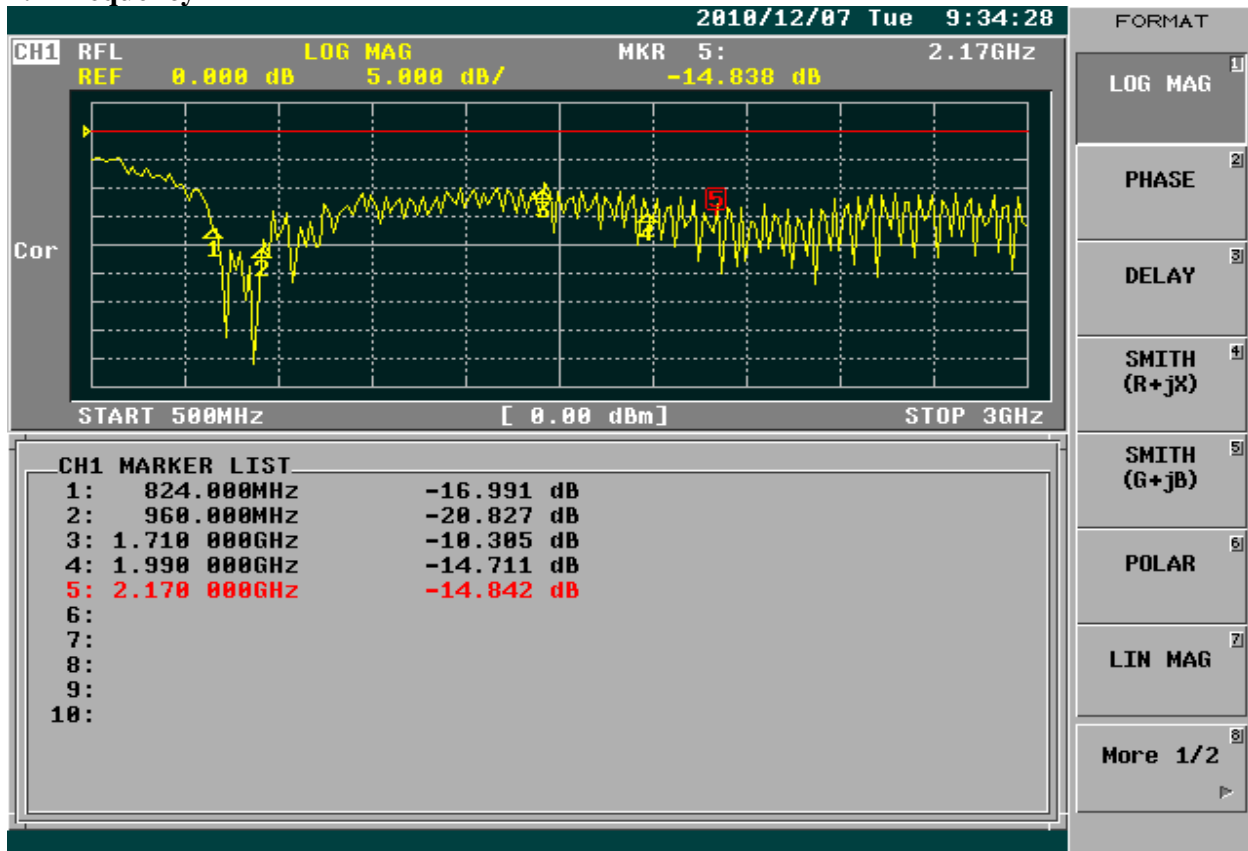

Far-field amplitude of 20101202 MA-83A 900-1800MHZ 0DBI E-PLANE.nsi

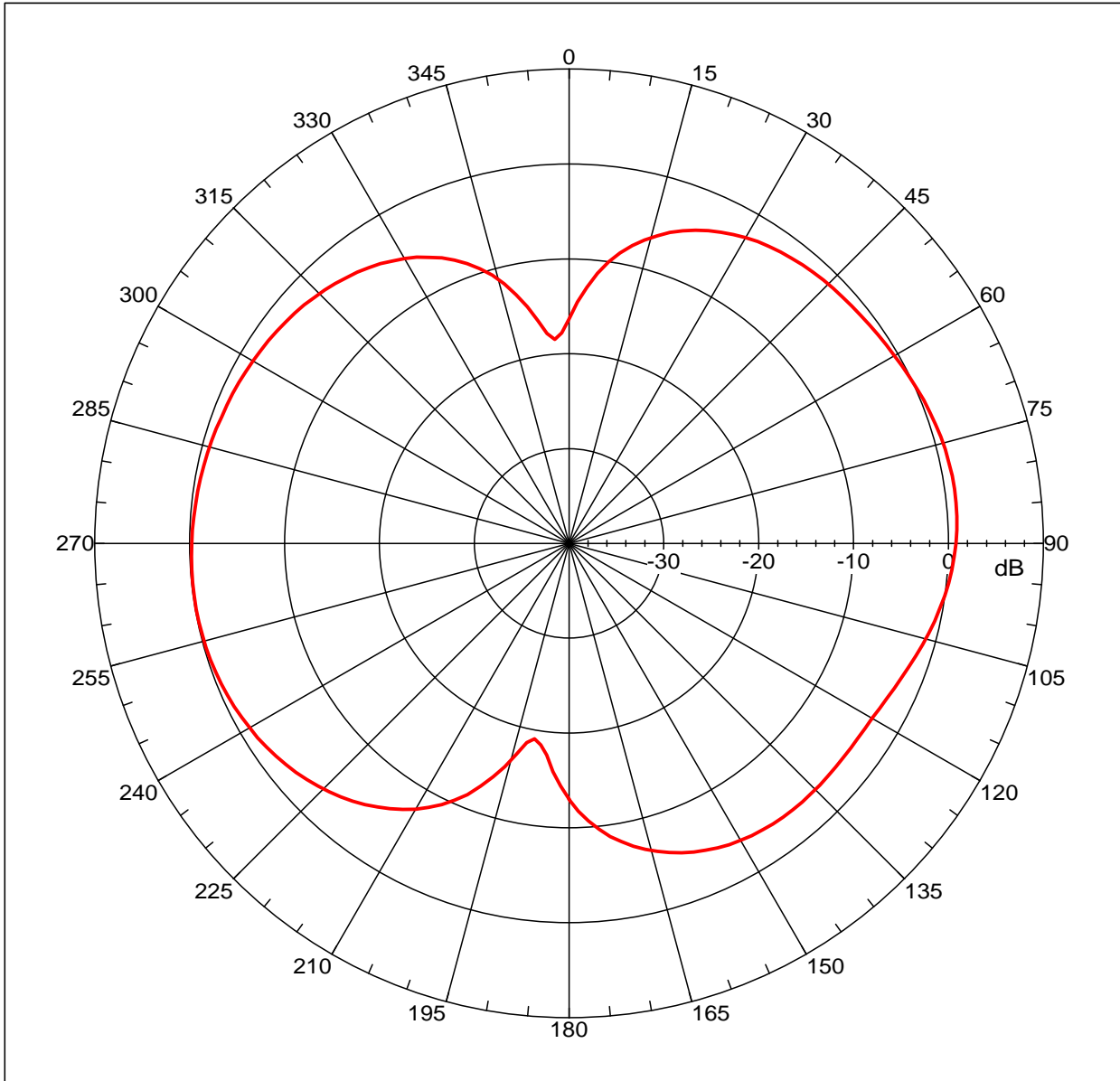

Far-field amplitude, Eprincipal: Linear, Tau = 0.000 deg
 Gain = 1.04332 dBi
 Max far-field (global) = -39.77861 dB, Max far-field (plot) = -39.77863 dB
 Normalization: Reference, Network offset = 0.000 dB
 Hpeak at: 81.99999 deg, Vpeak at: 0.000 deg
 Plot centering: On

20101202 MA-83A 900/1800MHZ 0DBI E-PLANE

NSI2000 V4.0.124, Filename:C:\nsi2000\Data\20101202 MA-83A 900-1800MHZ 0DBI E-PLANE.nsi
 Measurement date/time: 12/2/2010 9:16:20 AM, Filetype: NSI-97

Far-field Cut Analysis:
 Avg value: -3.352 dB
 -3. dB beam width: 73.71 deg
 -6. dB beam width: 139.08 deg
 -10. dB beam width: 163.31 deg
 Left Sidelobe: -1.16 dB at -95.531 deg
 Right Sidelobe: Not Found
 Far-field display setup
 Azimuth (deg)
 Span = 360.00001 deg, Center = 0.000 deg, #pts = 181
 Start = -180.00001 deg, Stop = 180.00001 deg, Delta = 2.000 deg
 Elevation (deg)
 Center = 0.000 deg, #pts = 1

Selected beam(s) 1 of 6

Beam	Frequency	Azimuth	Elevation	Pol
1	0.870 GHz	Azimuth	Elevation	Single-pol

Far-field amplitude of 20101202 MA-83A 900-1800MHZ 0DBI E-PLANE.nsi

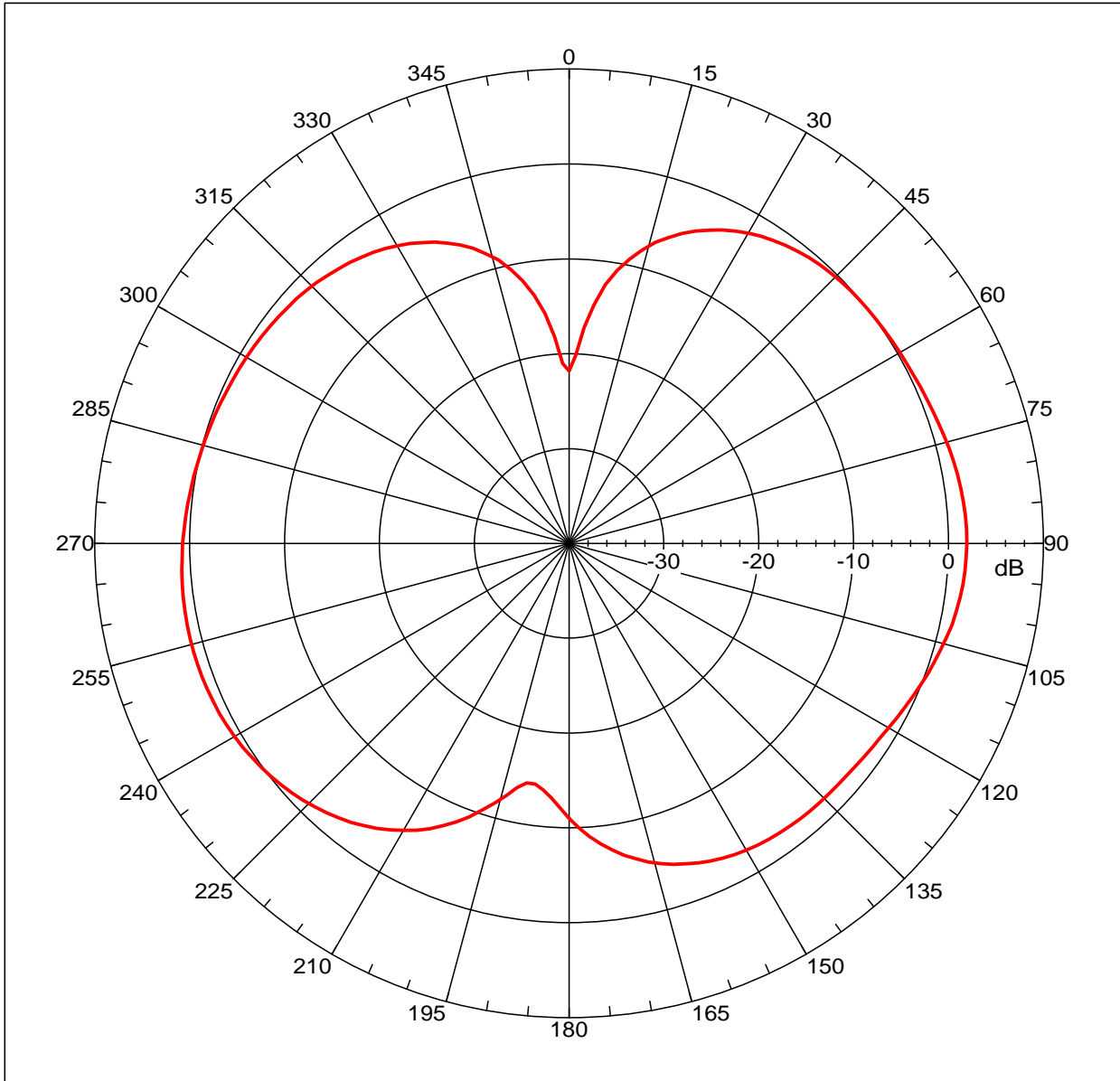

Far-field amplitude, Eprincipal: Linear, Tau = 0.000 deg
 Gain = 1.92143 dBi
 Max far-field (global) = -39.6197 dB, Max far-field (plot) = -39.6197 dB
 Normalization: Reference, Network offset = 0.000 dB
 Hpeak at: 90.000 deg, Vpeak at: 0.000 deg
 Plot centering: On

20101202 MA-83A 900/1800MHZ 0DBI E-PLANE

NSI2000 V4.0.124, Filename: C:\nsi2000\Data\20101202 MA-83A 900-1800MHZ 0DBI E-PLANE.nsi
 Measurement date/time: 12/2/2010 9:16:20 AM, Filetype: NSI-97

Far-field Cut Analysis:
 Avg value: -2.139 dB
 -3. dB beam width: 83.49 deg
 -6. dB beam width: 137.62 deg
 -10. dB beam width: 160.53 deg
 Left Sidelobe: -0.75 dB at -105.587 deg
 Right Sidelobe: Not Found

Far-field display setup
 Azimuth (deg)
 Span = 360.00001 deg, Center = 0.000 deg, #pts = 181
 Start = -180.00001 deg, Stop = 180.00001 deg, Delta = 2.000 deg
 Elevation (deg)
 Center = 0.000 deg, #pts = 1

Selected beam(s) 1 of 6

Beam	Frequency	Azimuth	Elevation	Pol
2	0.920 GHz	Azimuth	Elevation	Single-pol

Far-field amplitude of 20101202 MA-83A 900-1800MHZ 0DBI E-PLANE.nsi

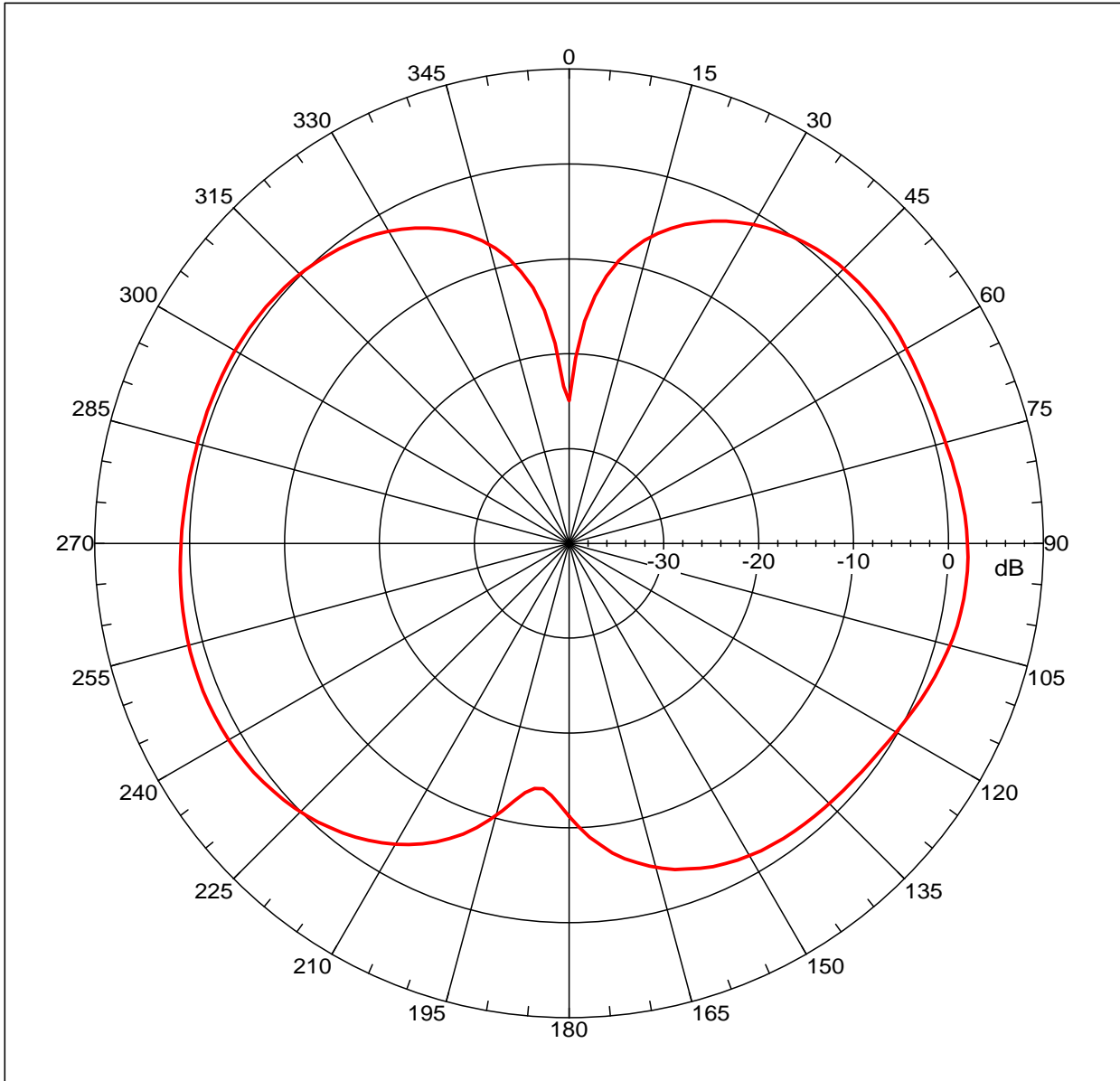

Far-field amplitude, Eprincipal: Linear, Tau = 0.000 deg
 Gain = 2.09073 dBi
 Max far-field (global) = -40.53894 dB, Max far-field (plot) = -40.53896 dB
 Normalization: Reference, Network offset = 0.000 dB
 Hpeak at: 93.99999 deg, Vpeak at: 0.000 deg
 Plot centering: On

20101202 MA-83A 900/1800MHZ 0DBI E-PLANE

NSI2000 V4.0.124, Filename: C:\nsi2000\Data\20101202 MA-83A 900-1800MHZ 0DBI E-PLANE.nsi
 Measurement date/time: 12/2/2010 9:16:20 AM, Filetype: NSI-97

Far-field Cut Analysis:
 Avg value: -1.329 dB
 -3. dB beam width: 97.67 deg
 -6. dB beam width: 142.11 deg
 -10. dB beam width: 161.95 deg
 Left Sidelobe: -1.46 dB at -61.341 deg
 Right Sidelobe: Not Found

Far-field display setup
 Azimuth (deg)
 Span = 360.00001 deg, Center = 0.000 deg, #pts = 181
 Start = -180.00001 deg, Stop = 180.00001 deg, Delta = 2.000 deg
 Elevation (deg)
 Center = 0.000 deg, #pts = 1

Selected beam(s) 1 of 6

Beam	Frequency	Azimuth	Elevation	Pol
3	0.960 GHz	Azimuth	Elevation	Single-pol

Far-field amplitude of 20101202 MA-83A 900-1800MHZ 0DBI E-PLANE.nsi

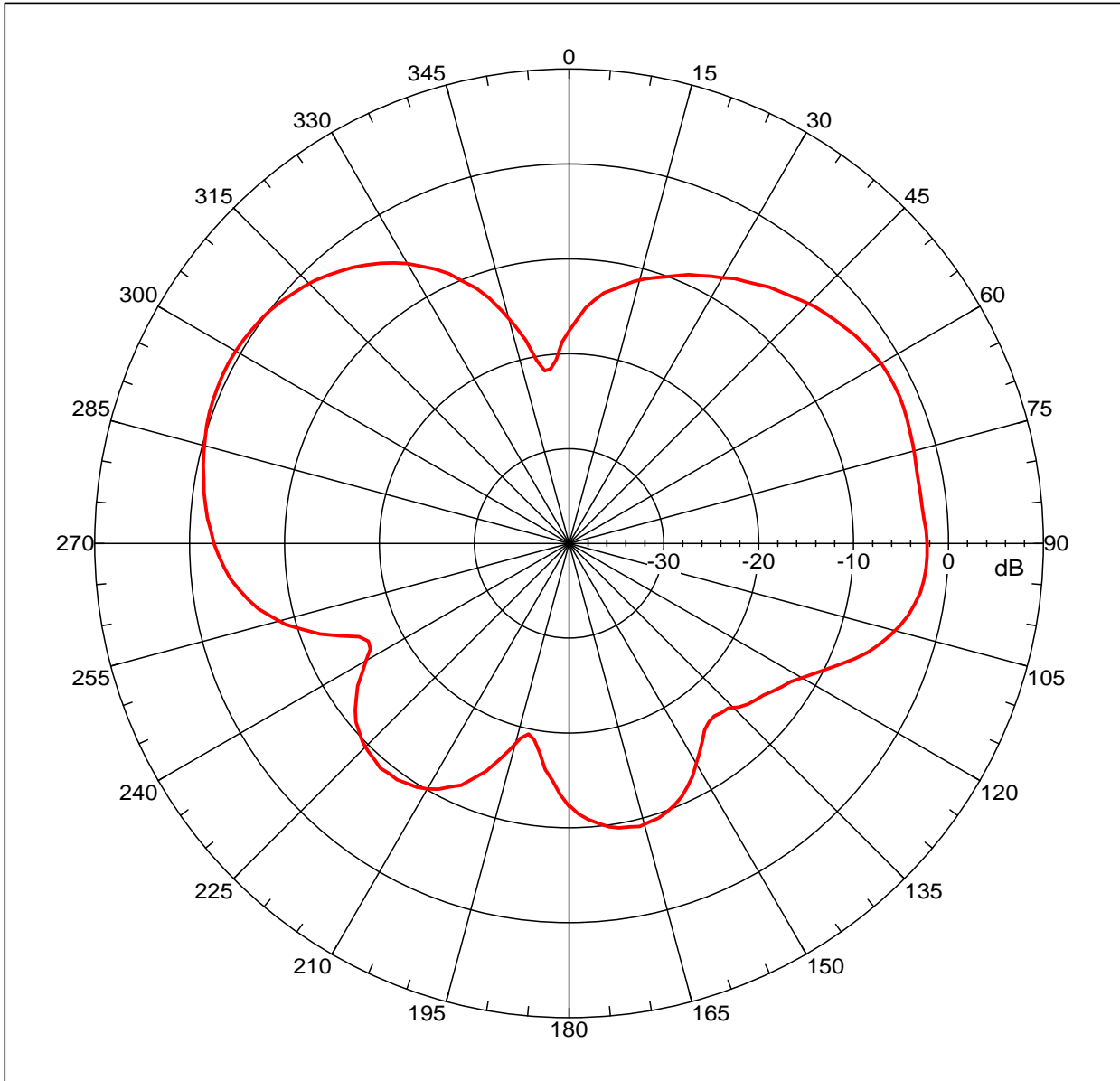

Far-field amplitude, Eprincipal: Linear, Tau = 0.000 deg
 Gain = 0.60922 dBi
 Max far-field (global) = -44.44111 dB, Max far-field (plot) = -44.44113 dB
 Normalization: Reference, Network offset = 0.000 dB
 Hpeak at: -62.000 deg, Vpeak at: 0.000 deg
 Plot centering: On

20101202 MA-83A 900/1800MHZ 0DBI E-PLANE

NSI2000 V4.0.124, Filename: C:\nsi2000\Data\20101202 MA-83A 900-1800MHZ 0DBI E-PLANE.nsi
 Measurement date/time: 12/2/2010 9:16:20 AM, Filetype: NSI-97

Far-field Cut Analysis:
 Avg value: -6.617 dB
 -3. dB beam width: 48.60 deg
 -6. dB beam width: 68.19 deg
 -10. dB beam width: 83.75 deg
 Left Sidelobe: -9.68 dB at -139.777 deg
 Right Sidelobe: -2.47 dB at 67.374 deg
 Far-field display setup
 Azimuth (deg)
 Span = 360.00001 deg, Center = 0.000 deg, #pts = 181
 Start = -180.00001 deg, Stop = 180.00001 deg, Delta = 2.000 deg
 Elevation (deg)
 Center = 0.000 deg, #pts = 1

Selected beam(s) 1 of 6

Beam	Frequency	Azimuth	Elevation	Pol
4	1.710 GHz	Azimuth	Elevation	Single-pol

Far-field amplitude of 20101202 MA-83A 900-1800MHZ 0DBI E-PLANE.nsi

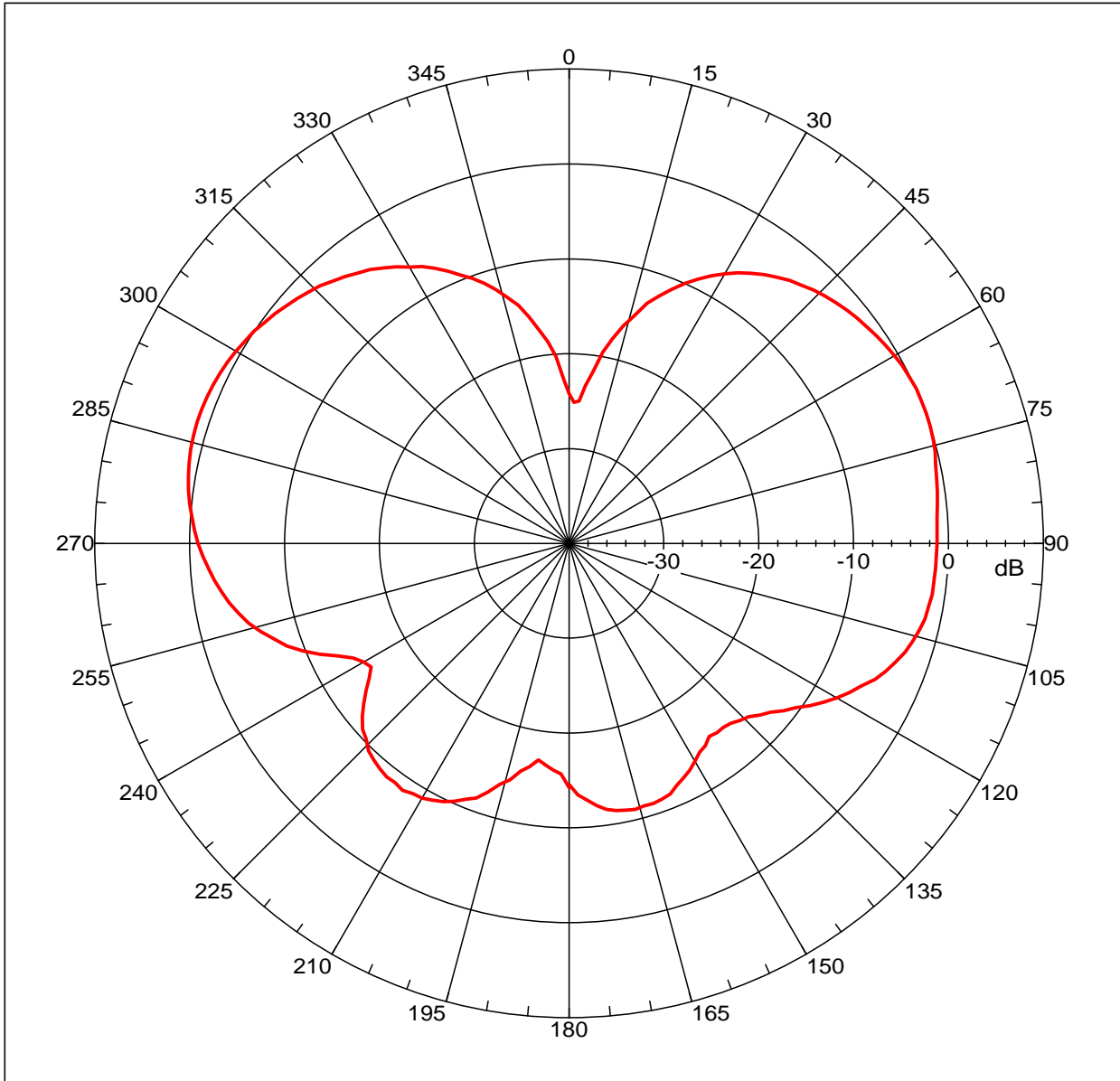

Far-field amplitude, Eprincipal: Linear, Tau = 0.000 deg
 Gain = 1.21482 dBi
 Max far-field (global) = -45.32755 dB, Max far-field (plot) = -45.32756 dB
 Normalization: Reference, Network offset = 0.000 dB
 Hpeak at: -72.00001 deg, Vpeak at: 0.000 deg
 Plot centering: On

20101202 MA-83A 900/1800MHZ 0DBI E-PLANE

NSI2000 V4.0.124, Filename: C:\nsi2000\Data\20101202 MA-83A 900-1800MHZ 0DBI E-PLANE.nsi
 Measurement date/time: 12/2/2010 9:16:20 AM, Filetype: NSI-97

Far-field Cut Analysis:
 Avg value: -5.693 dB
 -3. dB beam width: 47.40 deg
 -6. dB beam width: 68.68 deg
 -10. dB beam width: 87.50 deg
 Left Sidelobe: -9.98 dB at -141.788 deg
 Right Sidelobe: -1.15 dB at 67.374 deg
 Far-field display setup
 Azimuth (deg)
 Span = 360.00001 deg, Center = 0.000 deg, #pts = 181
 Start = -180.00001 deg, Stop = 180.00001 deg, Delta = 2.000 deg
 Elevation (deg)
 Center = 0.000 deg, #pts = 1

Selected beam(s) 1 of 6

Beam	Frequency	Azimuth	Elevation	Pol
5	1.800 GHz	Azimuth	Elevation	Single-pol

Far-field amplitude of 20101202 MA-83A 900-1800MHZ 0DBI E-PLANE.nsi

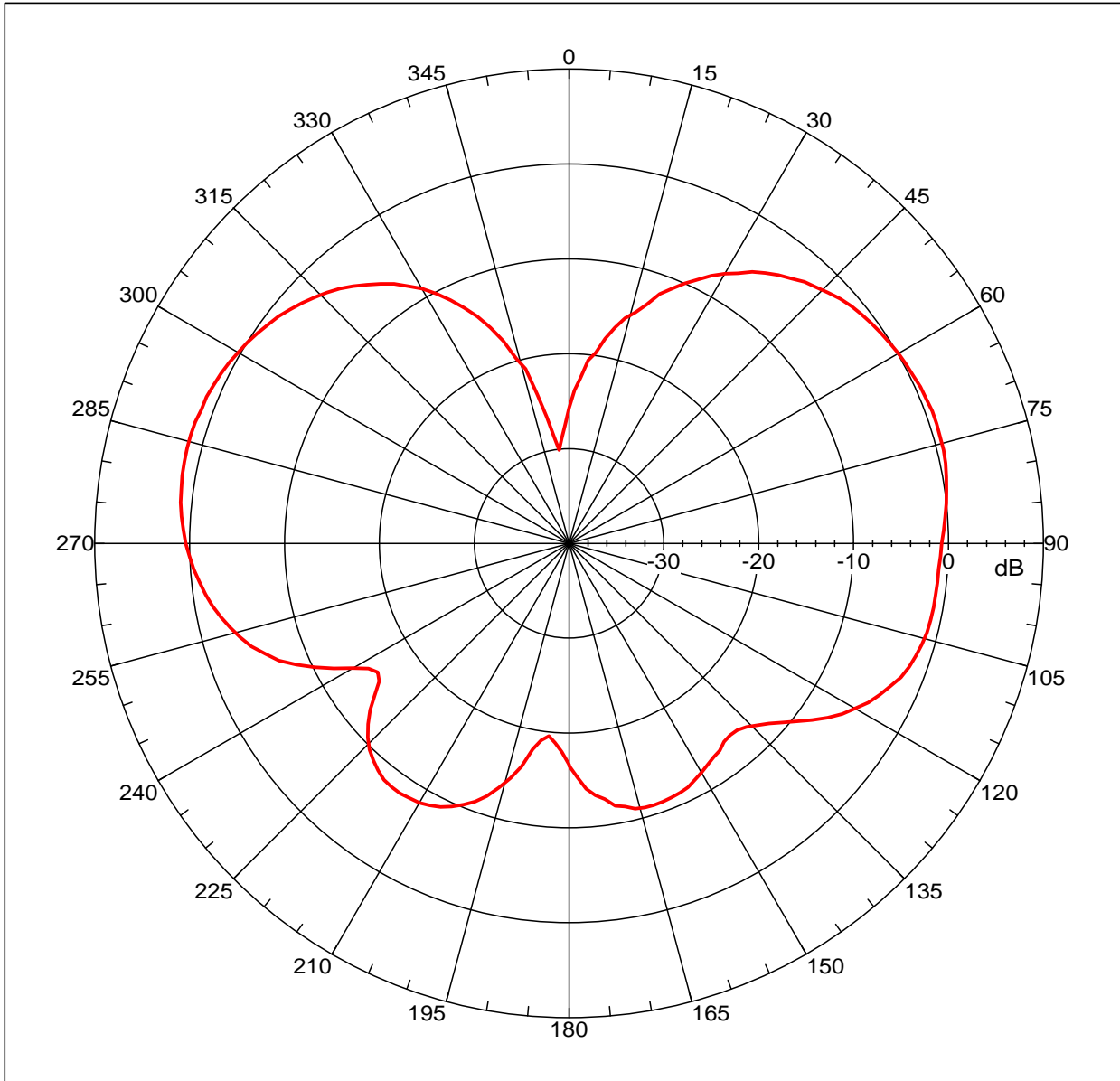

Far-field amplitude, Eprincipal: Linear, Tau = 0.000 deg
 Gain = 1.47834 dBi
 Max far-field (global) = -45.06409 dB, Max far-field (plot) = -45.06409 dB
 Normalization: Reference, Network offset = 0.000 dB
 Hpeak at: -76.00001 deg, Vpeak at: 0.000 deg
 Plot centering: On

20101202 MA-83A 900/1800MHZ 0DBI E-PLANE

NSI2000 V4.0.124, Filename: C:\nsi2000\Data\20101202 MA-83A 900-1800MHZ 0DBI E-PLANE.nsi
 Measurement date/time: 12/2/2010 9:16:20 AM, Filetype: NSI-97

Far-field Cut Analysis:
 Avg value: -5.355 dB
 -3. dB beam width: 48.51 deg
 -6. dB beam width: 67.44 deg
 -10. dB beam width: 83.43 deg
 Left Sidelobe: -9.65 dB at -145.810 deg
 Right Sidelobe: -0.75 dB at 73.408 deg
 Far-field display setup
 Azimuth (deg)
 Span = 360.00001 deg, Center = 0.000 deg, #pts = 181
 Start = -180.00001 deg, Stop = 180.00001 deg, Delta = 2.000 deg
 Elevation (deg)
 Center = 0.000 deg, #pts = 1

Selected beam(s) 1 of 6

Beam	Frequency	Azimuth	Elevation	Pol
6	1.880 GHz	Azimuth	Elevation	Single-pol

Far-field amplitude of 20101202 MA-83A 900-1800MHZ ODBI H-PLANE01.nsi

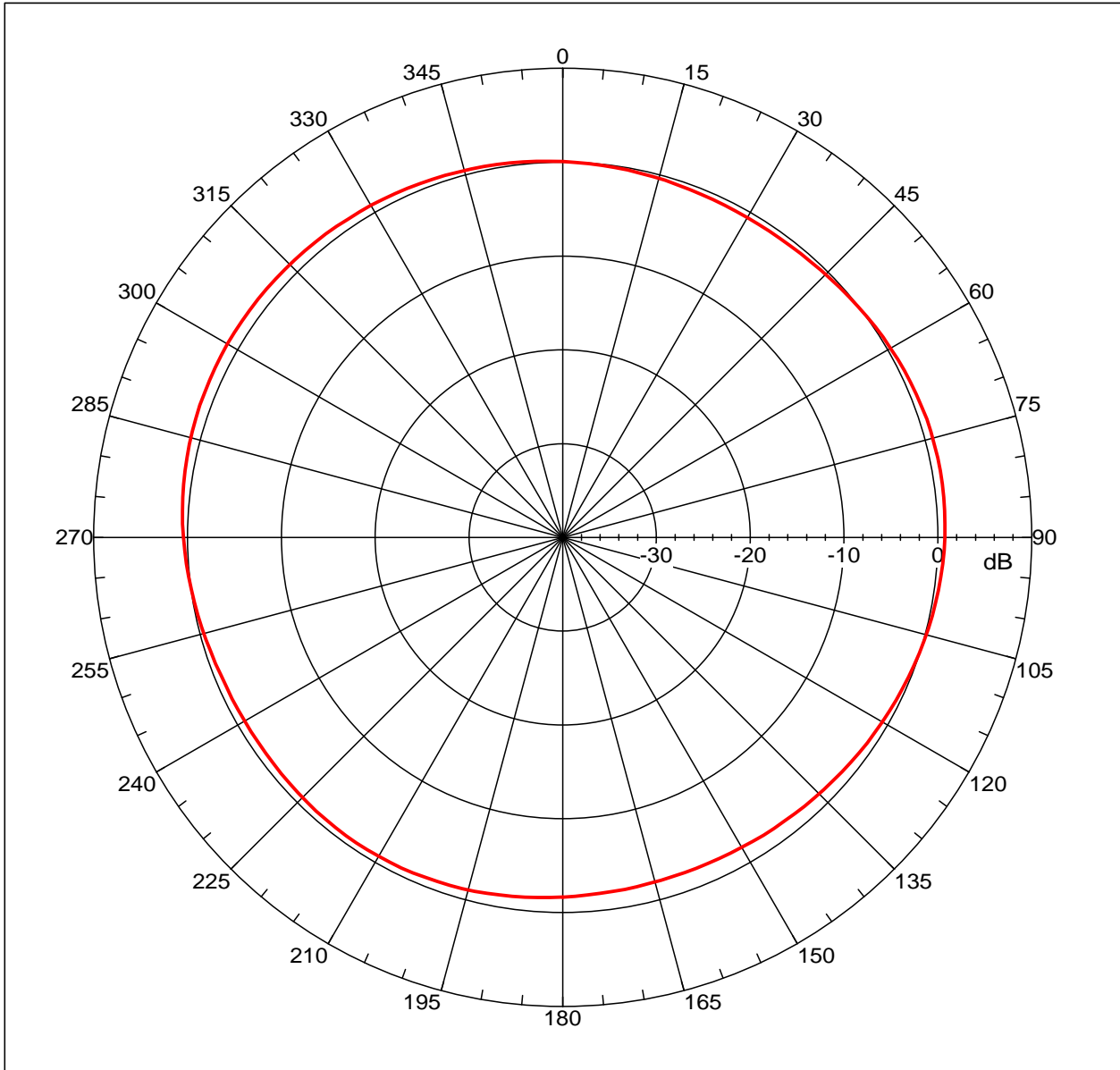

Far-field amplitude, Eprincipal: Linear, Tau = 0.000 deg
 Gain = 1.24205 dBi
 Max far-field (global) = -39.57988 dB, Max far-field (plot) = -39.57988 dB
 Normalization: Reference, Network offset = 0.000 dB
 Hpeak at: -60.00001 deg, Vpeak at: 0.000 deg
 Plot centering: On

20101202 MA-83A 900/1800MHZ ODBI H-PLANE

NSI2000 V4.0.124, Filename:C:\nsi2000\Data\20101202 MA-83A 900-1800MHZ ODBI H-PLANE01.nsi
 Measurement date/time: 12/2/2010 9:20:24 AM, Filetype: NSI-97

Far-field Cut Analysis:
 Avg value: -0.184 dB
 -3. dB beam width: Not Found
 -6. dB beam width: Not Found
 -10. dB beam width: Not Found
 Left Sidelobe: Not Found
 Right Sidelobe: -0.37 dB at 81.453 deg
 Far-field display setup
 Azimuth (deg)
 Span = 360.00001 deg, Center = 0.000 deg, #pts = 181
 Start = -180.00001 deg, Stop = 180.00001 deg, Delta = 2.000 deg
 Elevation (deg)
 Center = 0.000 deg, #pts = 1

Selected beam(s) 1 of 6

Beam	Frequency	Azimuth	Elevation	Pol
1	0.870 GHz	Azimuth	Elevation	Single-pol

Far-field amplitude of 20101202 MA-83A 900-1800MHZ ODBI H-PLANE01.nsi

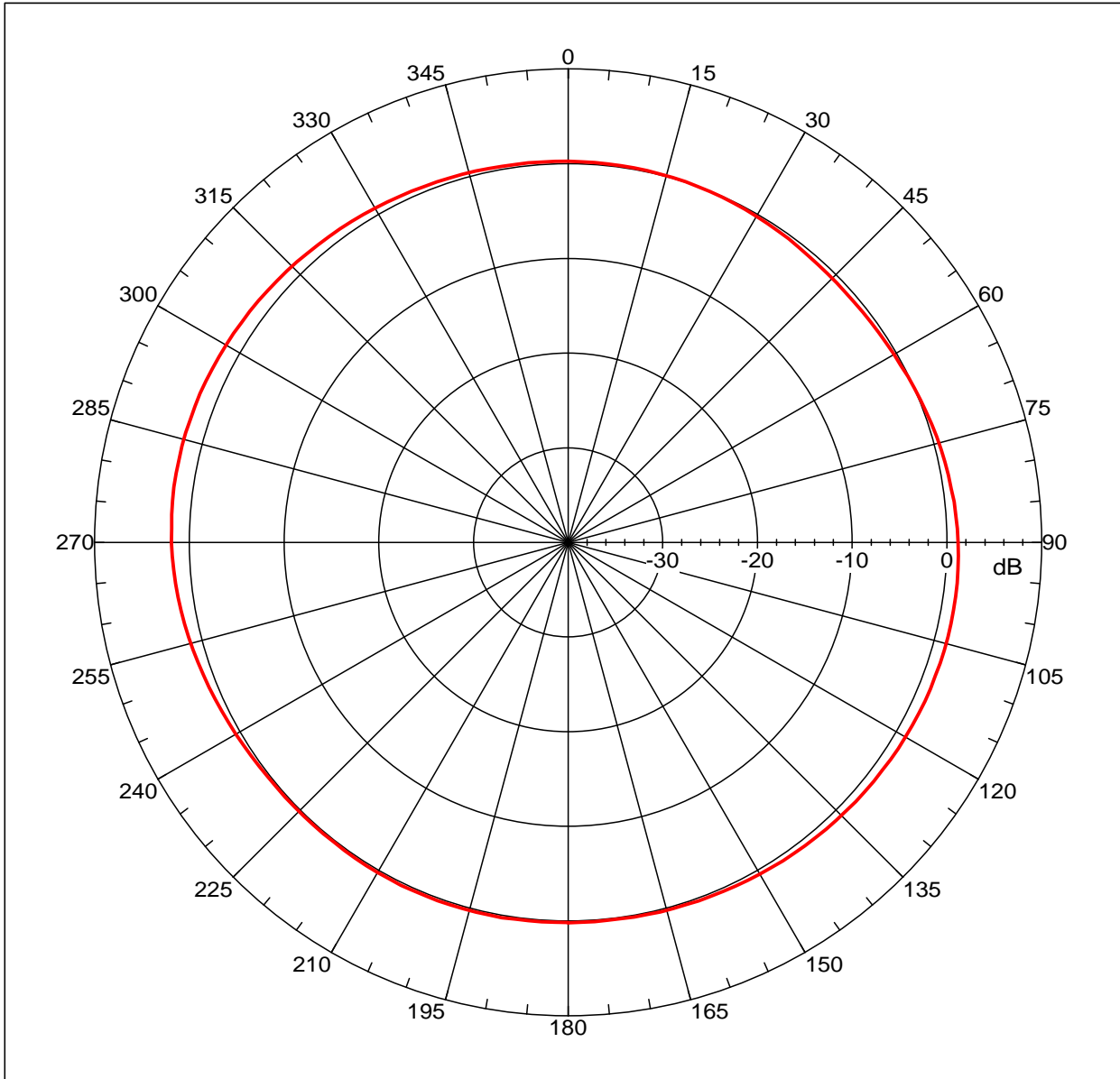

Far-field amplitude, Eprincipal: Linear, Tau = 0.000 deg
 Gain = 2.00626 dBi
 Max far-field (global) = -39.53487 dB, Max far-field (plot) = -39.53488 dB
 Normalization: Reference, Network offset = 0.000 dB
 Hpeak at: -80.000 deg, Vpeak at: 0.000 deg
 Plot centering: On

20101202 MA-83A 900/1800MHZ ODBI H-PLANE

NSI2000 V4.0.124, Filename:C:\nsi2000\Data\20101202 MA-83A 900-1800MHZ ODBI H-PLANE01.nsi
 Measurement date/time: 12/2/2010 9:20:24 AM, Filetype: NSI-97

Far-field Cut Analysis:
 Avg value: 0.659 dB
 -3. dB beam width: Not Found
 -6. dB beam width: Not Found
 -10. dB beam width: Not Found
 Left Sidelobe: Not Found
 Right Sidelobe: -0.69 dB at 101.564 deg

Far-field display setup
 Azimuth (deg)
 Span = 360.00001 deg, Center = 0.000 deg, #pts = 181
 Start = -180.00001 deg, Stop = 180.00001 deg, Delta = 2.000 deg
 Elevation (deg)
 Center = 0.000 deg, #pts = 1

Selected beam(s) 1 of 6

Beam	Frequency	Azimuth	Elevation	Pol
2	0.920 GHz	Azimuth	Elevation	Single-pol

Far-field amplitude of 20101202 MA-83A 900-1800MHZ ODBI H-PLANE01.nsi

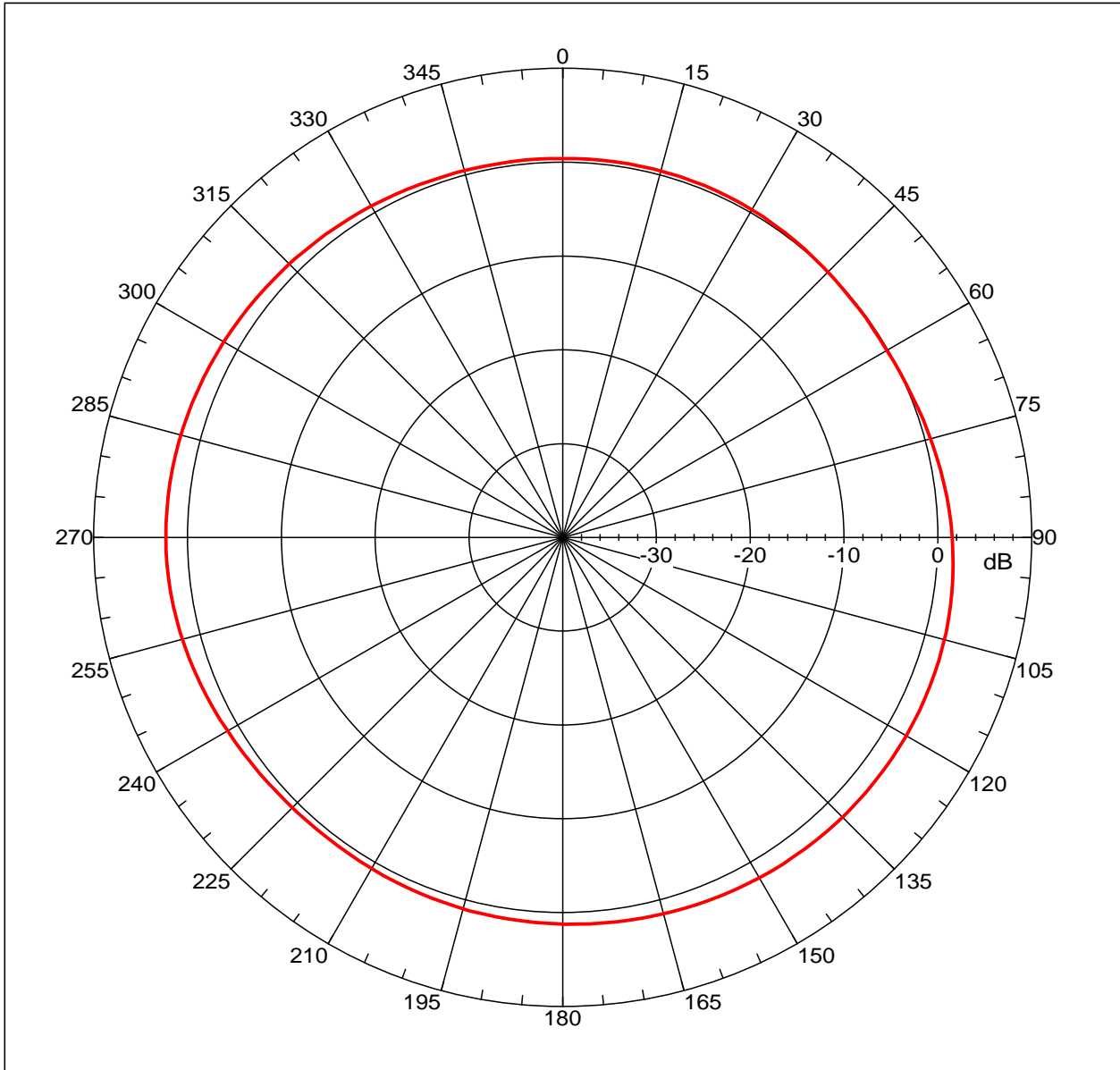

Far-field amplitude, Eprincipal: Linear, Tau = 0.000 deg
 Gain = 2.29702 dBi
 Max far-field (global) = -40.33265 dB, Max far-field (plot) = -40.33266 dB
 Normalization: Reference, Network offset = 0.000 dB
 Hpeak at: -88.00001 deg, Vpeak at: 0.000 deg
 Plot centering: On

20101202 MA-83A 900/1800MHZ ODBI H-PLANE

NSI2000 V4.0.124, Filename:C:\nsi2000\Data\20101202 MA-83A 900-1800MHZ ODBI H-PLANE01.nsi
 Measurement date/time: 12/2/2010 9:20:24 AM, Filetype: NSI-97

Far-field Cut Analysis:
 Avg value: 1.220 dB
 -3. dB beam width: Not Found
 -6. dB beam width: Not Found
 -10. dB beam width: Not Found
 Left Sidelobe: Not Found
 Right Sidelobe: -0.02 dB at 117.654 deg

Far-field display setup
 Azimuth (deg)
 Span = 360.00001 deg, Center = 0.000 deg, #pts = 181
 Start = -180.00001 deg, Stop = 180.00001 deg, Delta = 2.000 deg
 Elevation (deg)
 Center = 0.000 deg, #pts = 1

Selected beam(s) 1 of 6

Beam	Frequency	Azimuth	Elevation	Pol
3	0.960 GHz	Azimuth	Elevation	Single-pol

Far-field amplitude of 20101202 MA-83A 900-1800MHZ ODBI H-PLANE01.nsi

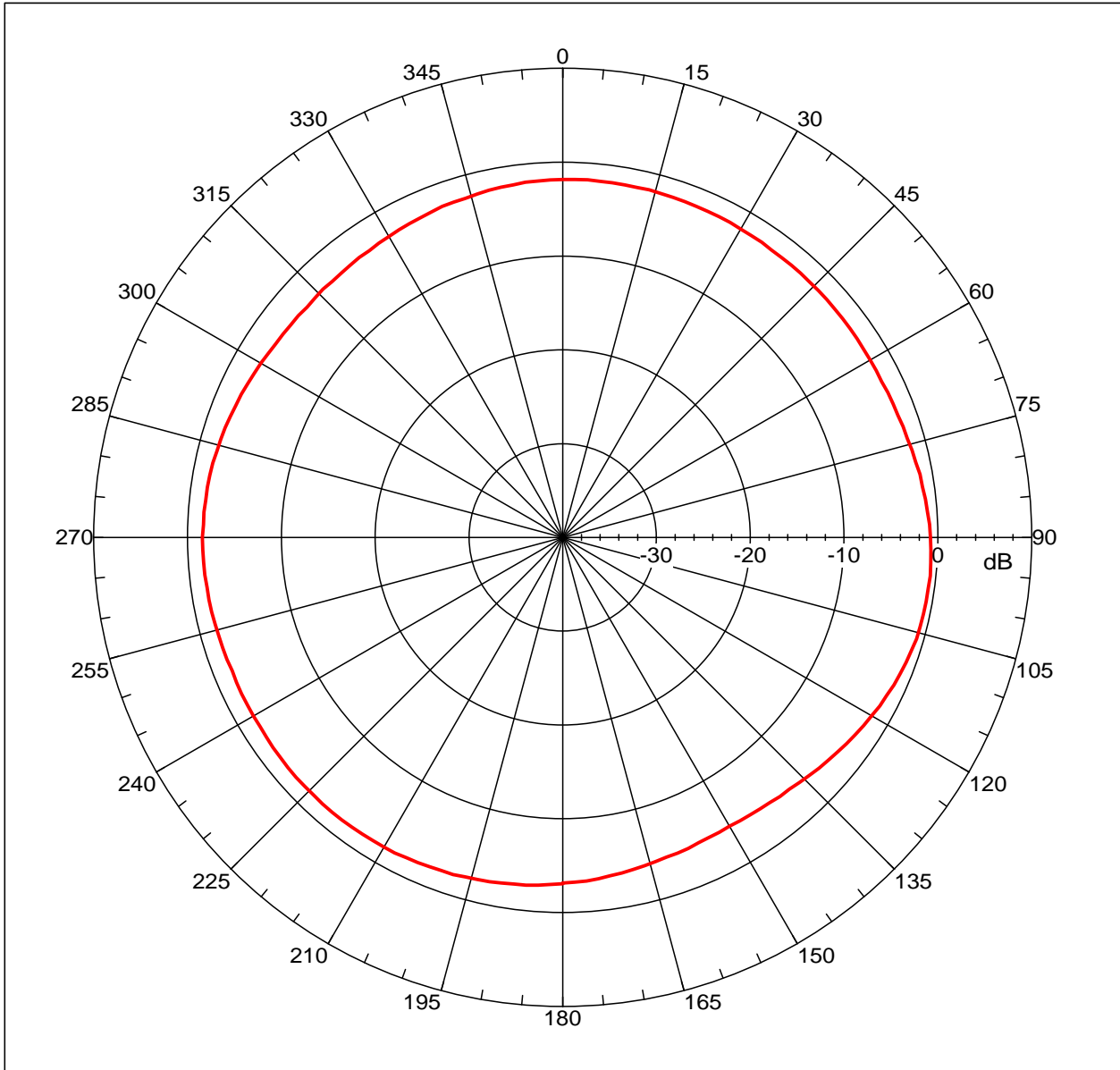

Far-field amplitude, Eprincipal: Linear, Tau = 0.000 deg
 Gain = -0.61608 dBi
 Max far-field (global) = -45.66641 dB, Max far-field (plot) = -45.66644 dB
 Normalization: Reference, Network offset = 0.000 dB
 Hpeak at: 96.000 deg, Vpeak at: 0.000 deg
 Plot centering: On

20101202 MA-83A 900/1800MHZ ODBI H-PLANE

NSI2000 V4.0.124, Filename:C:\nsi2000\Data\20101202 MA-83A 900-1800MHZ ODBI H-PLANE01.nsi
 Measurement date/time: 12/2/2010 9:20:24 AM, Filetype: NSI-97

Far-field Cut Analysis:
 Avg value: -2.264 dB
 -3. dB beam width: Not Found
 -6. dB beam width: Not Found
 -10. dB beam width: Not Found
 Left Sidelobe: -1.06 dB at -85.475 deg
 Right Sidelobe: Not Found

Far-field display setup
 Azimuth (deg)
 Span = 360.00001 deg, Center = 0.000 deg, #pts = 181
 Start = -180.00001 deg, Stop = 180.00001 deg, Delta = 2.000 deg
 Elevation (deg)
 Center = 0.000 deg, #pts = 1

Selected beam(s) 1 of 6

Beam	Frequency	Azimuth	Elevation	Pol
4	1.710 GHz	Azimuth	Elevation	Single-pol

Far-field amplitude of 20101202 MA-83A 900-1800MHZ ODBI H-PLANE01.nsi

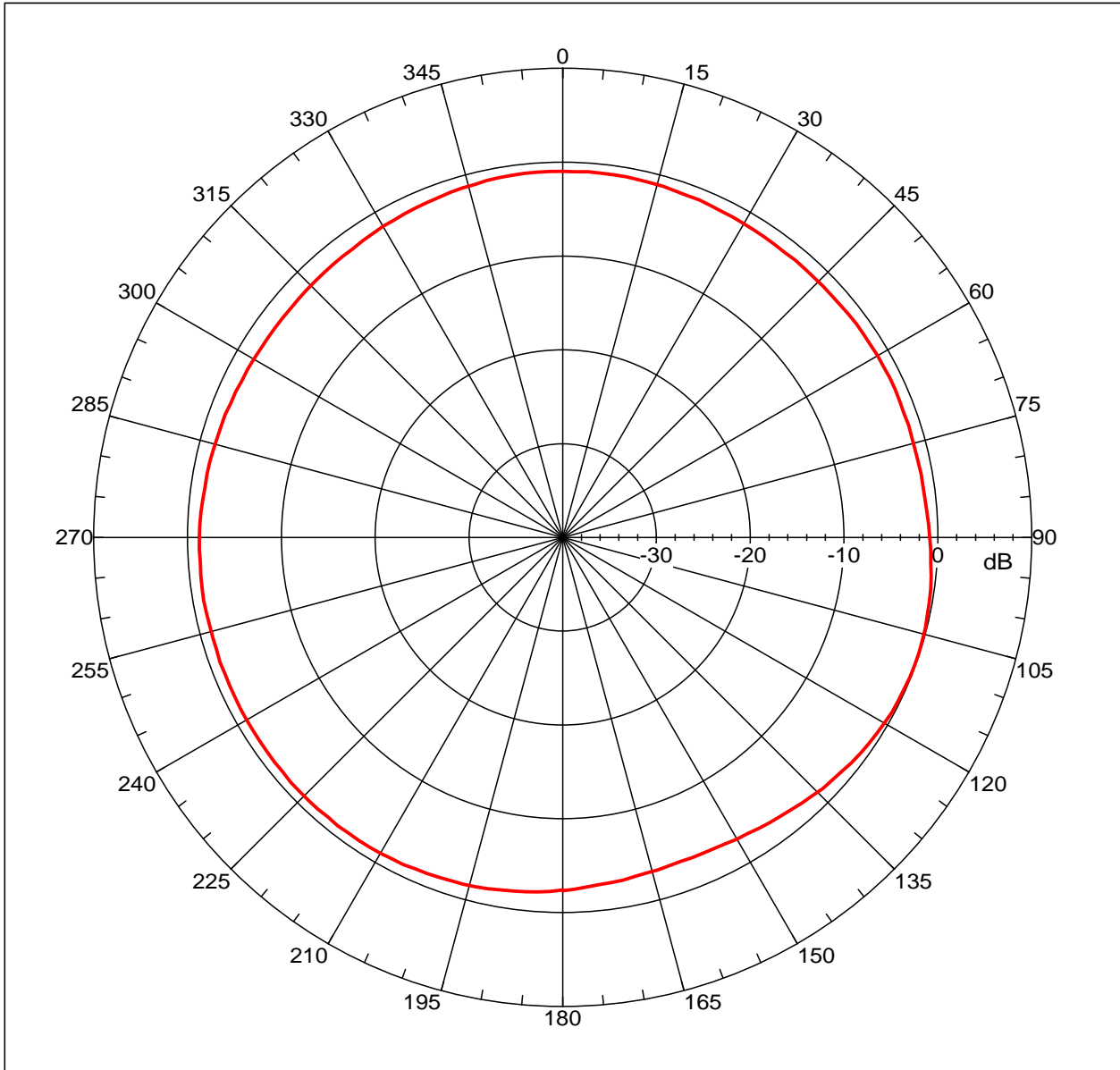

Far-field amplitude, Eprincipal: Linear, Tau = 0.000 deg
 Gain = -0.07998 dBi
 Max far-field (global) = -46.62235 dB, Max far-field (plot) = -46.62238 dB
 Normalization: Reference, Network offset = 0.000 dB
 Hpeak at: 107.99999 deg, Vpeak at: 0.000 deg
 Plot centering: On

20101202 MA-83A 900/1800MHZ ODBI H-PLANE

NSI2000 V4.0.124, Filename:C:\nsi2000\Data\20101202 MA-83A 900-1800MHZ ODBI H-PLANE01.nsi
 Measurement date/time: 12/2/2010 9:20:24 AM, Filetype: NSI-97

Far-field Cut Analysis:
 Avg value: -1.434 dB
 -3. dB beam width: Not Found
 -6. dB beam width: Not Found
 -10. dB beam width: Not Found
 Left Sidelobe: -1.02 dB at -117.654 deg
 Right Sidelobe: Not Found

Far-field display setup
 Azimuth (deg)
 Span = 360.00001 deg, Center = 0.000 deg, #pts = 181
 Start = -180.00001 deg, Stop = 180.00001 deg, Delta = 2.000 deg
 Elevation (deg)
 Center = 0.000 deg, #pts = 1

Selected beam(s) 1 of 6

Beam	Frequency	Azimuth	Elevation	Pol
5	1.800 GHz	Azimuth	Elevation	Single-pol

Far-field amplitude of 20101202 MA-83A 900-1800MHZ ODBI H-PLANE01.nsi

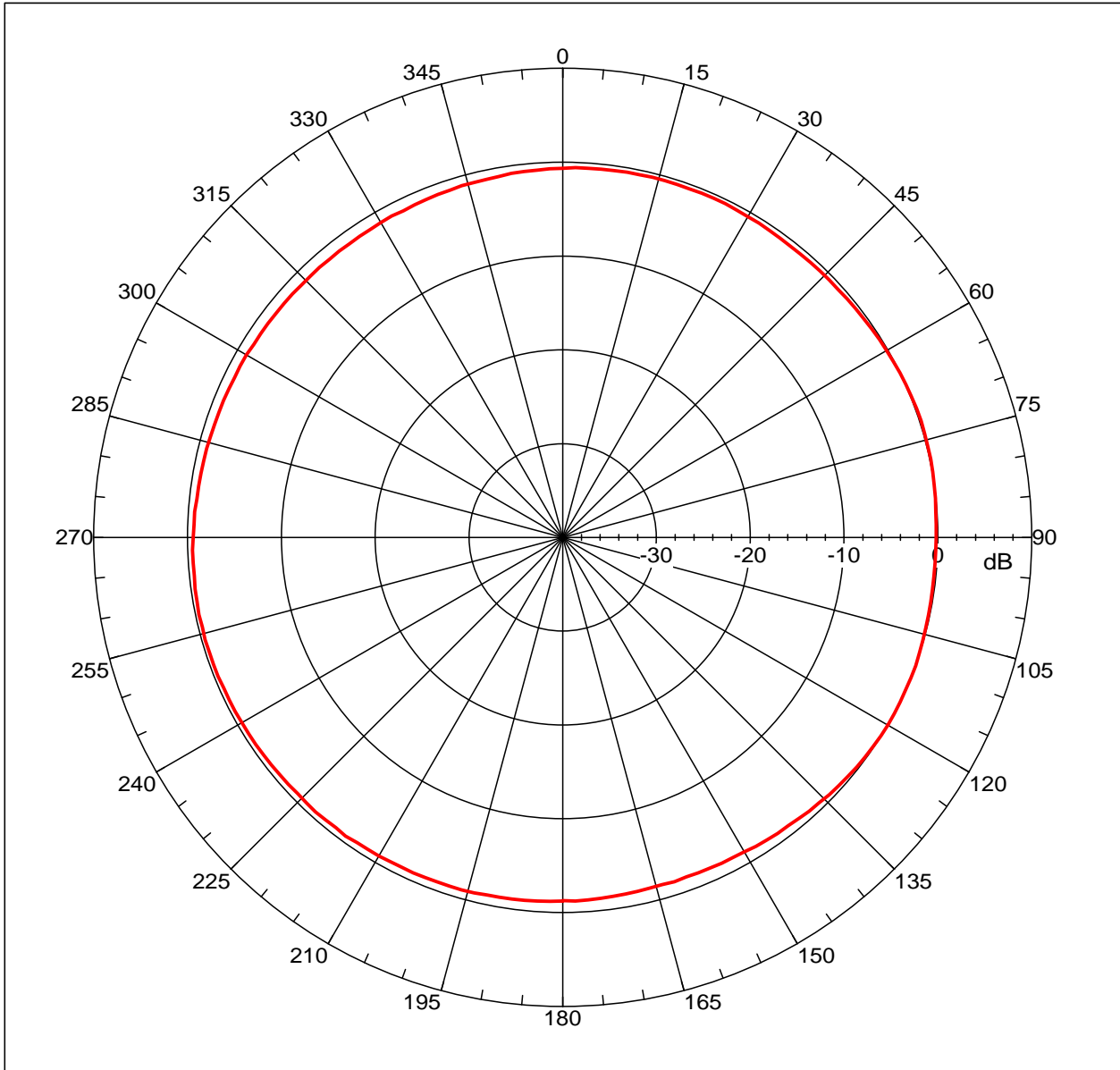

Far-field amplitude, Eprincipal: Linear, Tau = 0.000 deg
 Gain = 0.15817 dBi
 Max far-field (global) = -46.38426 dB, Max far-field (plot) = -46.38426 dB
 Normalization: Reference, Network offset = 0.000 dB
 Hpeak at: 72.000 deg, Vpeak at: 0.000 deg
 Plot centering: On

20101202 MA-83A 900/1800MHZ ODBI H-PLANE

NSI2000 V4.0.124, Filename:C:\nsi2000\Data\20101202 MA-83A 900-1800MHZ ODBI H-PLANE01.nsi
 Measurement date/time: 12/2/2010 9:20:24 AM, Filetype: NSI-97

Far-field Cut Analysis:
 Avg value: -0.682 dB
 -3. dB beam width: Not Found
 -6. dB beam width: Not Found
 -10. dB beam width: Not Found
 Left Sidelobe: Not Found
 Right Sidelobe: Not Found
 Far-field display setup
 Azimuth (deg)
 Span = 360.00001 deg, Center = 0.000 deg, #pts = 181
 Start = -180.00001 deg, Stop = 180.00001 deg, Delta = 2.000 deg
 Elevation (deg)
 Center = 0.000 deg, #pts = 1

Selected beam(s) 1 of 6

Beam	Frequency	Azimuth	Elevation	Pol
6	1.880 GHz	Azimuth	Elevation	Single-pol

Far-field amplitude of 20101202 MA-83A 900-1800MHZ 3DBI E-PLANE1.nsi

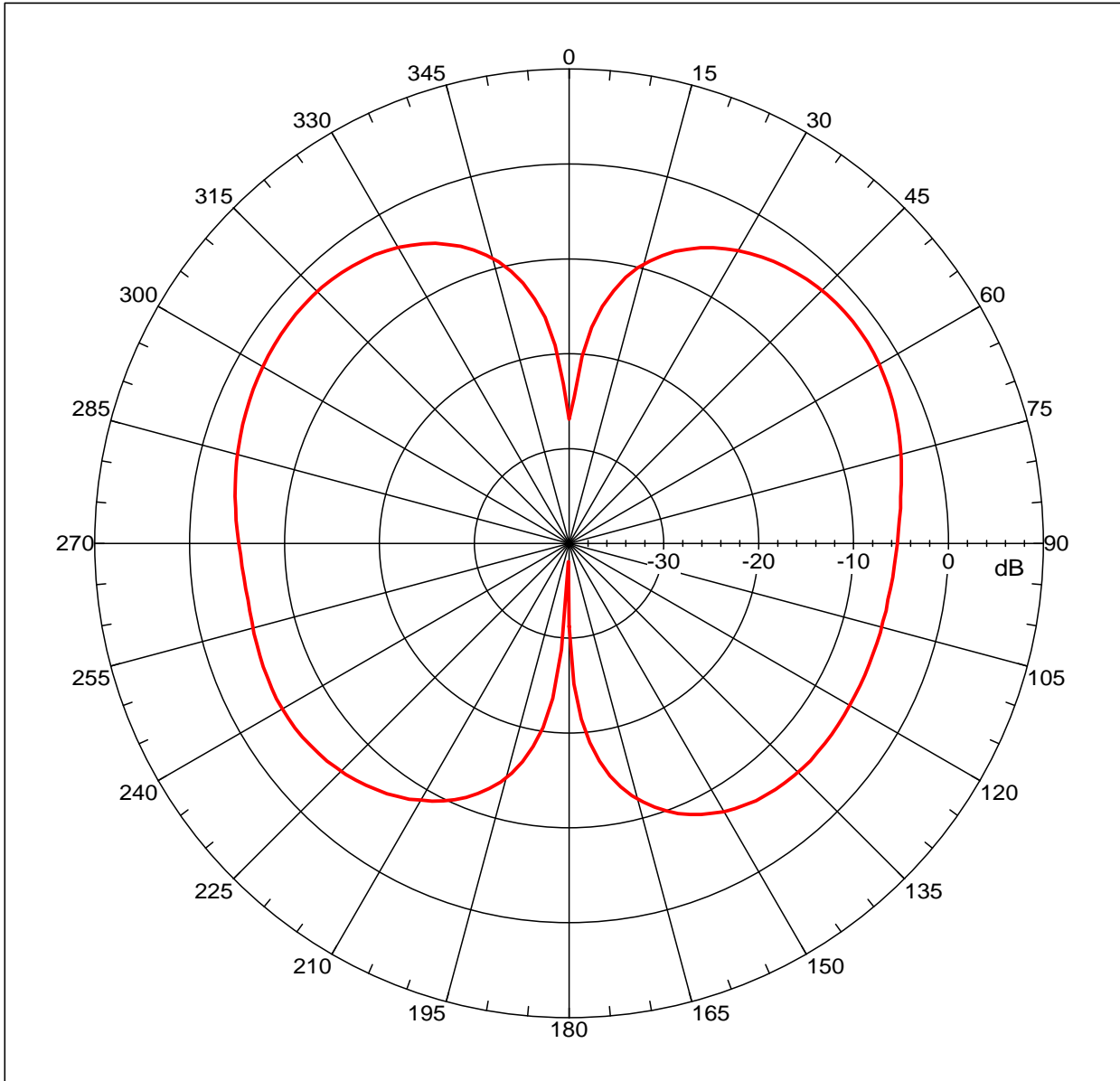

Far-field amplitude, Eprincipal: Linear, Tau = 0.000 deg
 Gain = -2.02687 dBi
 Max far-field (global) = -42.8488 dB, Max far-field (plot) = -42.84882 dB
 Normalization: Reference, Network offset = 0.000 dB
 Hpeak at: 51.99999 deg, Vpeak at: 0.000 deg
 Plot centering: On

20101202 MA-83A 900/1800MHZ 3DBI E-PLANE

NSI2000 V4.0.124, Filename:C:\nsi2000\Data\20101202 MA-83A 900-1800MHZ 3DBI E-PLANE1.nsi
 Measurement date/time: 12/2/2010 9:28:25 AM, Filetype: NSI-97

Far-field Cut Analysis:
 Avg value: -6.180 dB
 -3. dB beam width: 58.37 deg
 -6. dB beam width: 135.77 deg
 -10. dB beam width: 154.54 deg
 Left Sidelobe: -0.38 dB at -49.274 deg
 Right Sidelobe: Not Found
 Far-field display setup
 Azimuth (deg)
 Span = 360.00001 deg, Center = 0.000 deg, #pts = 181
 Start = -180.00001 deg, Stop = 180.00001 deg, Delta = 2.000 deg
 Elevation (deg)
 Center = 0.000 deg, #pts = 1

Selected beam(s) 1 of 6

Beam	Frequency	Azimuth	Elevation	Pol
1	0.870 GHz	Azimuth	Elevation	Single-pol

Far-field amplitude of 20101202 MA-83A 900-1800MHZ 3DBI E-PLANE1.nsi

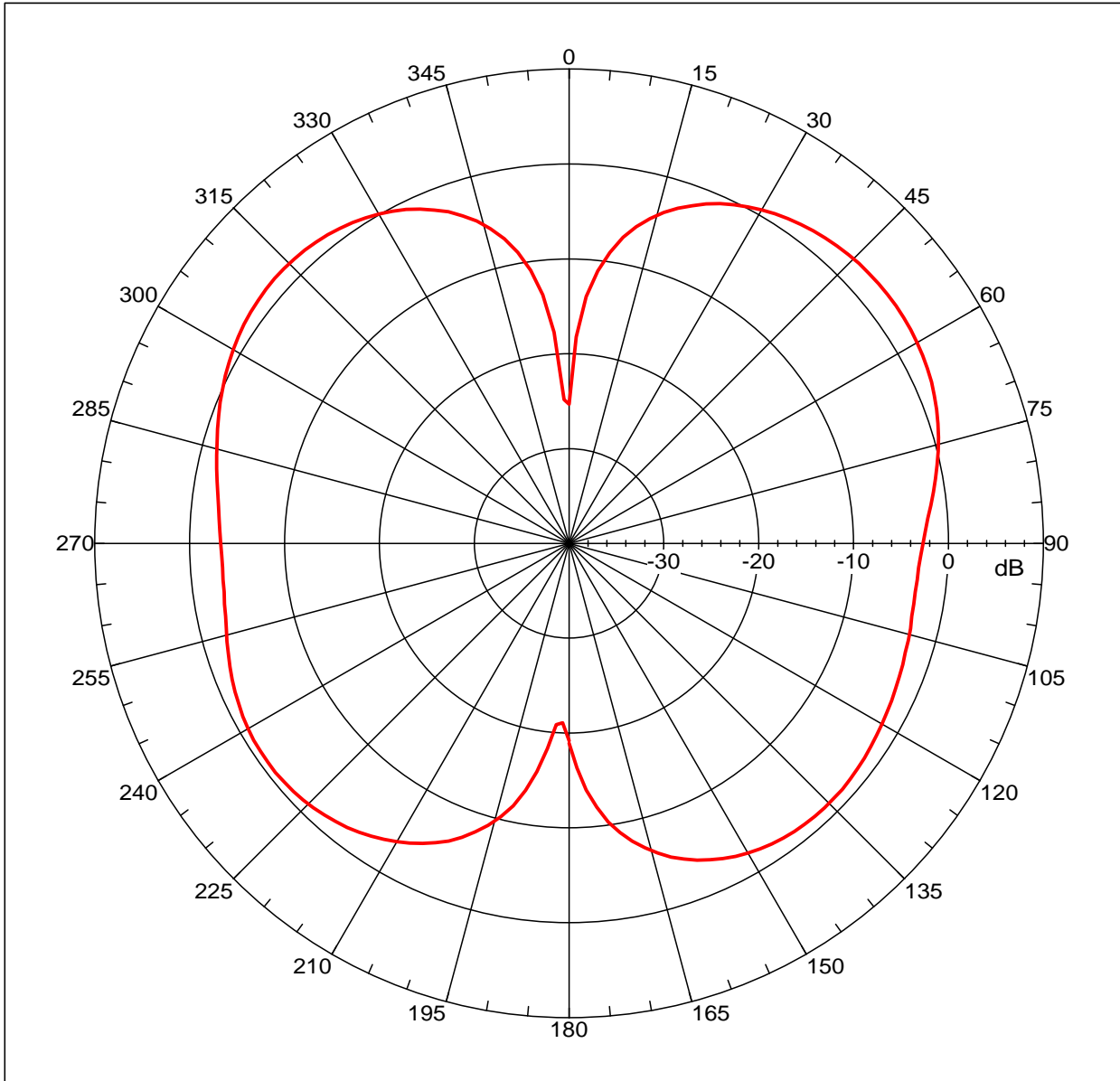

Far-field amplitude, Eprincipal: Linear, Tau = 0.000 deg
 Gain = 2.5916 dBi
 Max far-field (global) = -38.94953 dB, Max far-field (plot) = -38.94955 dB
 Normalization: Reference, Network offset = 0.000 dB
 Hpeak at: 53.99999 deg, Vpeak at: 0.000 deg
 Plot centering: On

20101202 MA-83A 900/1800MHZ 3DBI E-PLANE

NSI2000 V4.0.124, Filename:C:\nsi2000\Data\20101202 MA-83A 900-1800MHZ 3DBI E-PLANE1.nsi
 Measurement date/time: 12/2/2010 9:28:25 AM, Filetype: NSI-97

Far-field Cut Analysis:

Avg value: -2.107 dB
 -3. dB beam width: 53.02 deg
 -6. dB beam width: 139.66 deg
 -10. dB beam width: 158.05 deg
 Left Sidelobe: -0.86 dB at -47.263 deg
 Right Sidelobe: -3.85 dB at 133.743 deg

Far-field display setup

Azimuth (deg)
 Span = 360.00001 deg, Center = 0.000 deg, #pts = 181
 Start = -180.00001 deg, Stop = 180.00001 deg, Delta = 2.000

deg

Elevation (deg)
 Center = 0.000 deg, #pts = 1

Selected beam(s) 1 of 6

Beam	Frequency	Azimuth	Elevation	Pol
2	0.920 GHz	Azimuth	Elevation	Single-pol

Far-field amplitude of 20101202 MA-83A 900-1800MHZ 3DBI E-PLANE1.nsi

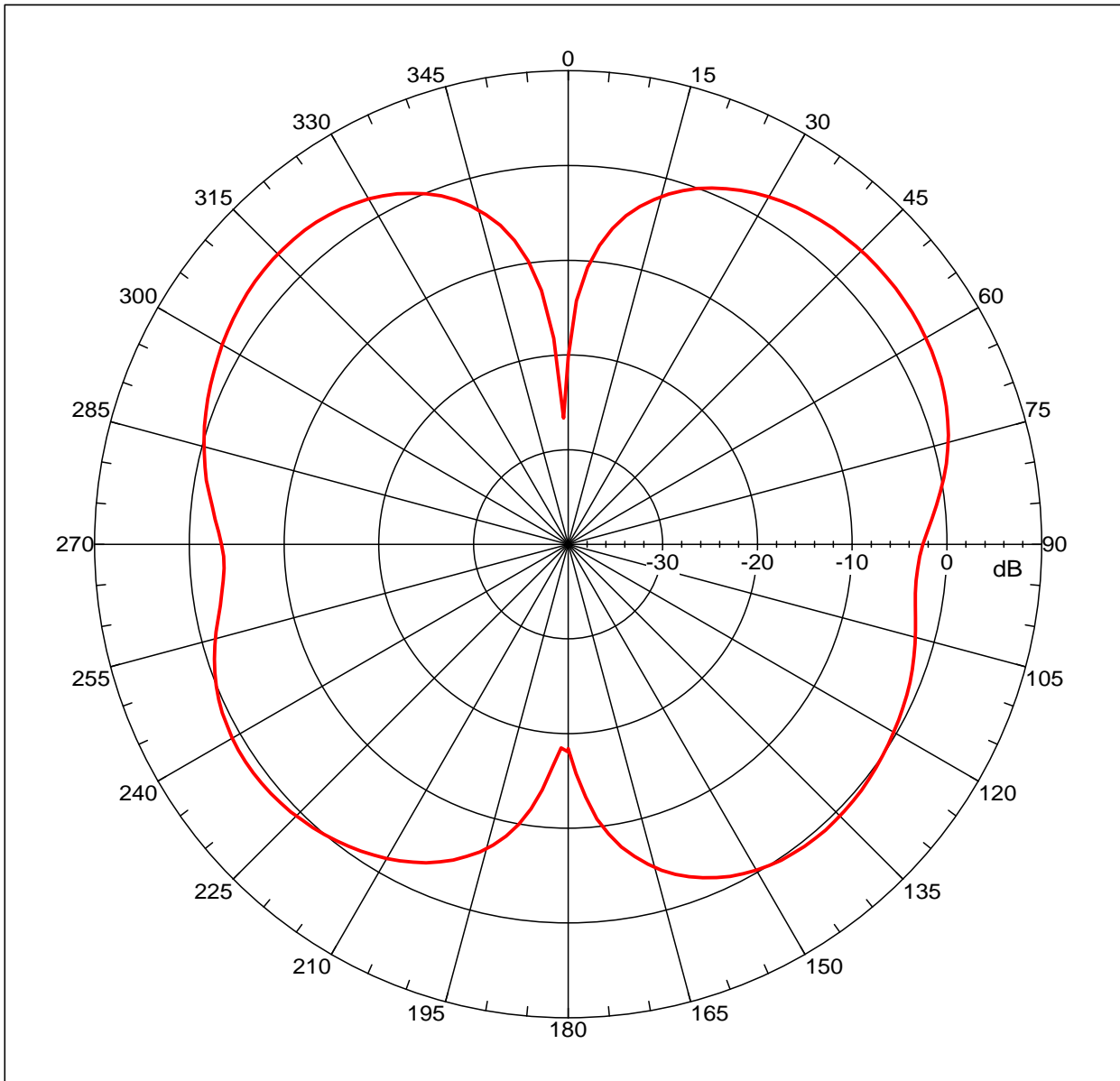

Far-field amplitude, Eprincipal: Linear, Tau = 0.000 deg
 Gain = 3.90236 dBi
 Max far-field (global) = -38.72731 dB, Max far-field (plot) = -38.72733 dB
 Normalization: Reference, Network offset = 0.000 dB
 Hpeak at: 51.99999 deg, Vpeak at: 0.000 deg
 Plot centering: On

20101202 MA-83A 900/1800MHZ 3DBI E-PLANE

NSI2000 V4.0.124, Filename:C:\nsi2000\Data\20101202 MA-83A 900-1800MHZ 3DBI E-PLANE1.nsi
 Measurement date/time: 12/2/2010 9:28:25 AM, Filetype: NSI-97

Far-field Cut Analysis:

Avg value: -0.588 dB
 -3. dB beam width: 54.61 deg
 -6. dB beam width: 73.70 deg
 -10. dB beam width: 160.17 deg
 Left Sidelobe: -0.57 dB at -43.240 deg
 Right Sidelobe: -3.30 dB at 139.777 deg

Far-field display setup

Azimuth (deg)
 Span = 360.00001 deg, Center = 0.000 deg, #pts = 181
 Start = -180.00001 deg, Stop = 180.00001 deg, Delta = 2.000

deg

Elevation (deg)
 Center = 0.000 deg, #pts = 1

Selected beam(s) 1 of 6

Beam	Frequency	Azimuth	Elevation	Pol
3	0.960 GHz	Azimuth	Elevation	Single-pol

Far-field amplitude of 20101202 MA-83A 900-1800MHZ 3DBI E-PLANE1.nsi

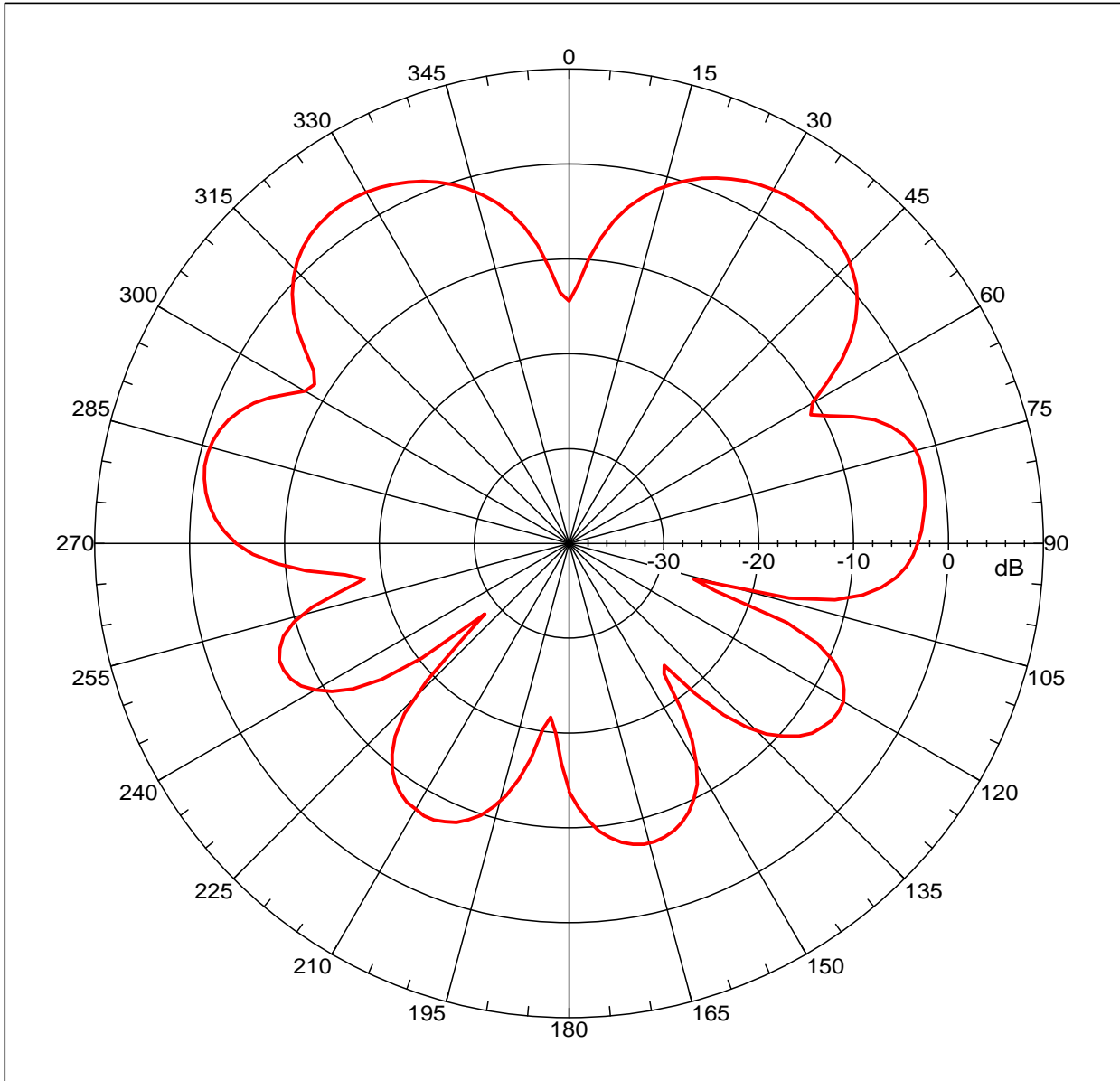

Far-field amplitude, Eprincipal: Linear, Tau = 0.000 deg
 Gain = 3.30101 dBi
 Max far-field (global) = -41.74932 dB, Max far-field (plot) = -41.74934 dB
 Normalization: Reference, Network offset = 0.000 dB
 Hpeak at: 33.99999 deg, Vpeak at: 0.000 deg
 Plot centering: On

20101202 MA-83A 900/1800MHZ 3DBI E-PLANE

NSI2000 V4.0.124, Filename:C:\nsi2000\Data\20101202 MA-83A 900-1800MHZ 3DBI E-PLANE1.nsi
 Measurement date/time: 12/2/2010 9:28:25 AM, Filetype: NSI-97

Far-field Cut Analysis:
 Avg value: -4.754 dB
 -3. dB beam width: 30.67 deg
 -6. dB beam width: 41.50 deg
 -10. dB beam width: 50.47 deg
 Left Sidelobe: -0.33 dB at -33.184 deg
 Right Sidelobe: -5.27 dB at 79.441 deg

Far-field display setup
 Azimuth (deg)
 Span = 360.00001 deg, Center = 0.000 deg, #pts = 181
 Start = -180.00001 deg, Stop = 180.00001 deg, Delta = 2.000 deg
 Elevation (deg)
 Center = 0.000 deg, #pts = 1

Selected beam(s) 1 of 6

Beam	Frequency	Azimuth	Elevation	Pol
4	1.710 GHz	Azimuth	Elevation	Single-pol

Far-field amplitude of 20101202 MA-83A 900-1800MHZ 3DBI E-PLANE1.nsi

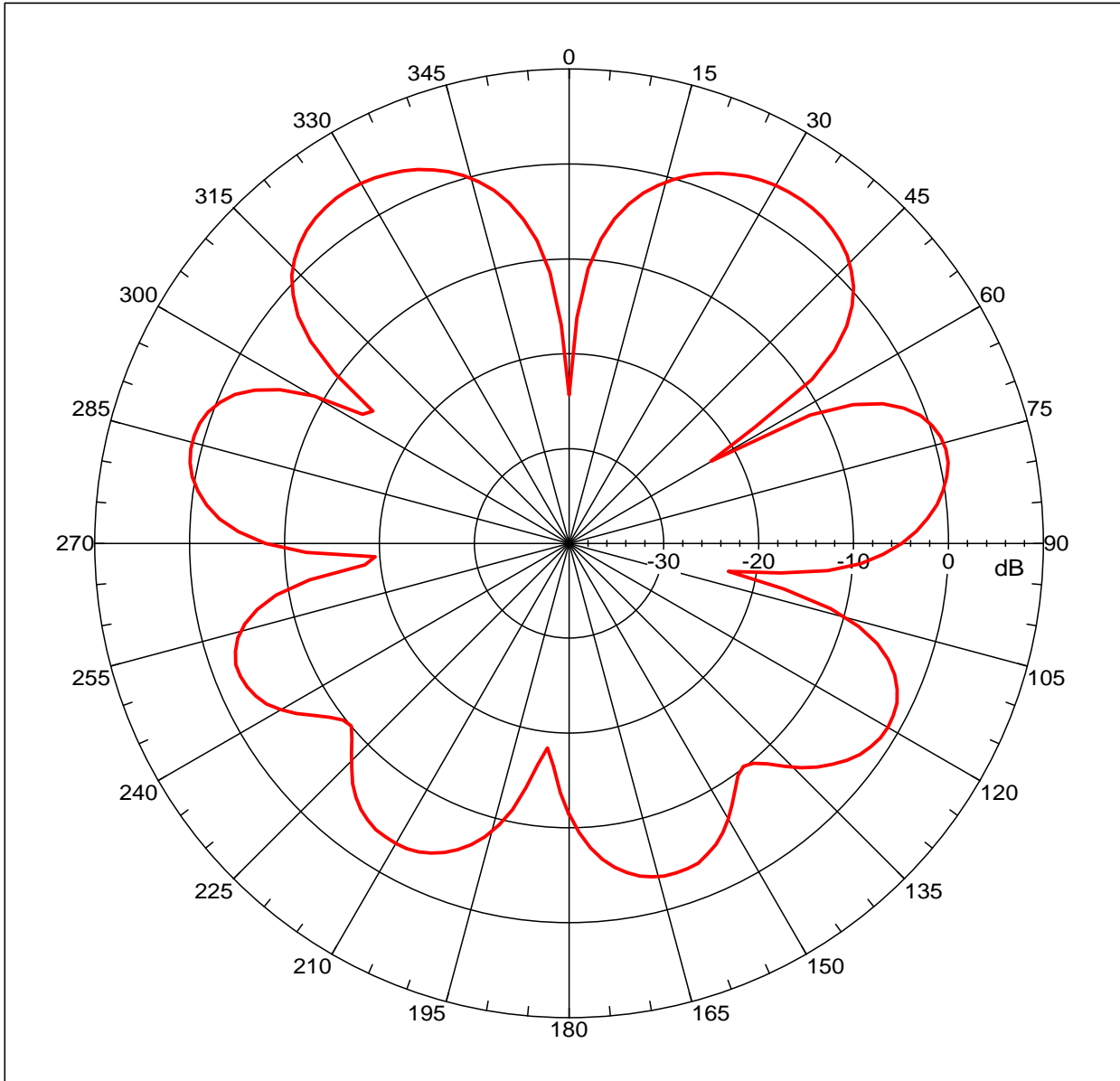

Far-field amplitude, Eprincipal: Linear, Tau = 0.000 deg
 Gain = 3.88977 dBi
 Max far-field (global) = -42.6526 dB, Max far-field (plot) = -42.65262 dB
 Normalization: Reference, Network offset = 0.000 dB
 Hpeak at: -32.00001 deg, Vpeak at: 0.000 deg
 Plot centering: On

20101202 MA-83A 900/1800MHZ 3DBI E-PLANE

NSI2000 V4.0.124, Filename: C:\nsi2000\Data\20101202 MA-83A 900-1800MHZ 3DBI E-PLANE1.nsi
 Measurement date/time: 12/2/2010 9:28:25 AM, Filetype: NSI-97

Far-field Cut Analysis:
 Avg value: -3.024 dB
 -3. dB beam width: 28.33 deg
 -6. dB beam width: 37.75 deg
 -10. dB beam width: 45.08 deg
 Left Sidelobe: -2.80 dB at -73.408 deg
 Right Sidelobe: -0.18 dB at 35.196 deg
 Far-field display setup
 Azimuth (deg)
 Span = 360.00001 deg, Center = 0.000 deg, #pts = 181
 Start = -180.00001 deg, Stop = 180.00001 deg, Delta = 2.000 deg
 Elevation (deg)
 Center = 0.000 deg, #pts = 1

Selected beam(s) 1 of 6

Beam	Frequency	Azimuth	Elevation	Pol
5	1.800 GHz	Azimuth	Elevation	Single-pol

Far-field amplitude of 20101202 MA-83A 900-1800MHZ 3DBI E-PLANE1.nsi

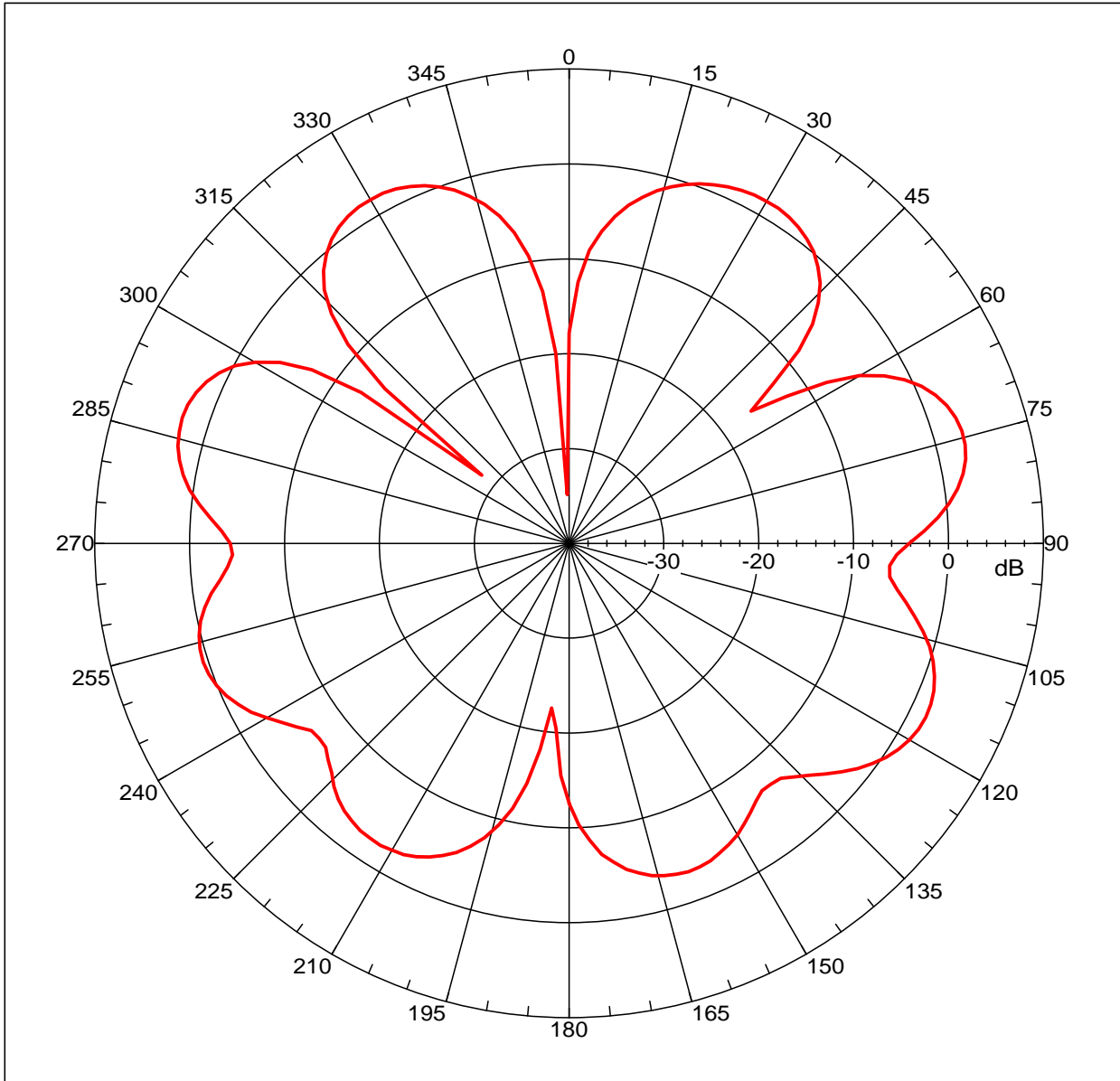

Far-field amplitude, Eprincipal: Linear, Tau = 0.000 deg
 Gain = 3.0519 dBi
 Max far-field (global) = -43.49053 dB, Max far-field (plot) = -43.49064 dB
 Normalization: Reference, Network offset = 0.000 dB
 Hpeak at: 73.99999 deg, Vpeak at: 0.000 deg
 Plot centering: On

20101202 MA-83A 900/1800MHZ 3DBI E-PLANE

NSI2000 V4.0.124, Filename: C:\nsi2000\Data\20101202 MA-83A 900-1800MHZ 3DBI E-PLANE1.nsi
 Measurement date/time: 12/2/2010 9:28:25 AM, Filetype: NSI-97

Far-field Cut Analysis:
 Avg value: -2.357 dB
 -3. dB beam width: 19.42 deg
 -6. dB beam width: 27.15 deg
 -10. dB beam width: 115.85 deg
 Left Sidelobe: -1.41 dB at 33.184 deg
 Right Sidelobe: -1.22 dB at 117.654 deg
 Far-field display setup
 Azimuth (deg)
 Span = 360.00001 deg, Center = 0.000 deg, #pts = 181
 Start = -180.00001 deg, Stop = 180.00001 deg, Delta = 2.000 deg
 Elevation (deg)
 Center = 0.000 deg, #pts = 1

Selected beam(s) 1 of 6

Beam	Frequency	Azimuth	Elevation	Pol
6	1.880 GHz	Azimuth	Elevation	Single-pol

Far-field amplitude of 20101202 MA-83A 900-1800MHZ 3DBI H-PLANE0.nsi

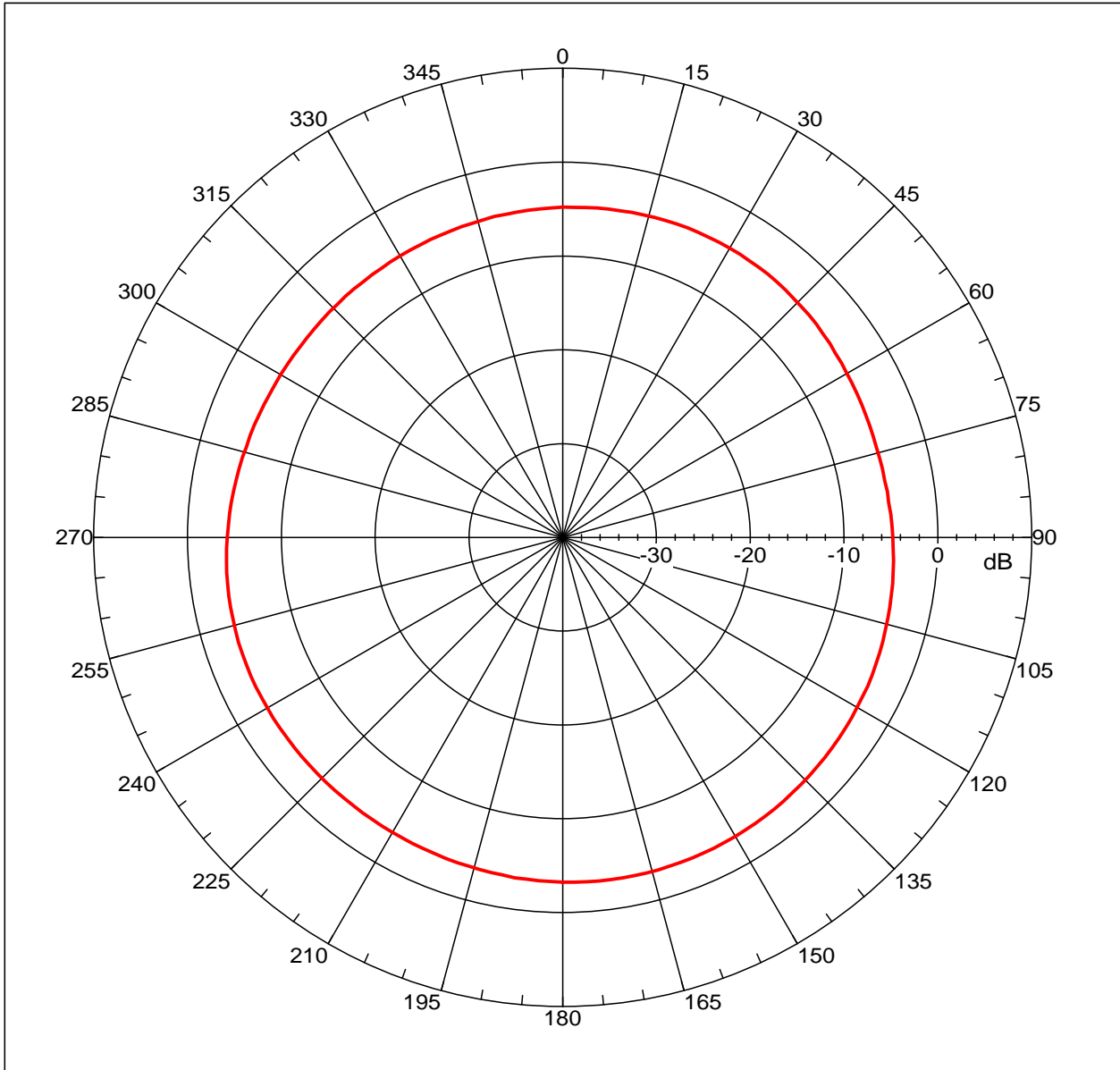

Far-field amplitude, Eprincipal: Linear, Tau = 0.000 deg
 Gain = -3.12295 dBi
 Max far-field (global) = -43.94488 dB, Max far-field (plot) = -43.94489 dB
 Normalization: Reference, Network offset = 0.000 dB
 Hpeak at: 163.99999 deg, Vpeak at: 0.000 deg
 Plot centering: On

20101202 MA-83A 900/1800MHZ 3DBI H-PLANE

NSI2000 V4.0.124, Filename:C:\nsi2000\Data\20101202 MA-83A 900-1800MHZ 3DBI H-PLANE0.nsi
 Measurement date/time: 12/2/2010 9:24:36 AM, Filetype: NSI-97

Far-field Cut Analysis:
 Avg value: -4.265 dB
 -3. dB beam width: Not Found
 -6. dB beam width: Not Found
 -10. dB beam width: Not Found
 Left Sidelobe: -0.55 dB at -109.609 deg
 Right Sidelobe: Not Found
 Far-field display setup
 Azimuth (deg)
 Span = 360.00001 deg, Center = 0.000 deg, #pts = 181
 Start = -180.00001 deg, Stop = 180.00001 deg, Delta = 2.000 deg
 Elevation (deg)
 Center = 0.000 deg, #pts = 1

Selected beam(s) 1 of 6

Beam	Frequency	Azimuth	Elevation	Pol
1	0.870 GHz	Azimuth	Elevation	Single-pol

Far-field amplitude of 20101202 MA-83A 900-1800MHZ 3DBI H-PLANE0.nsi

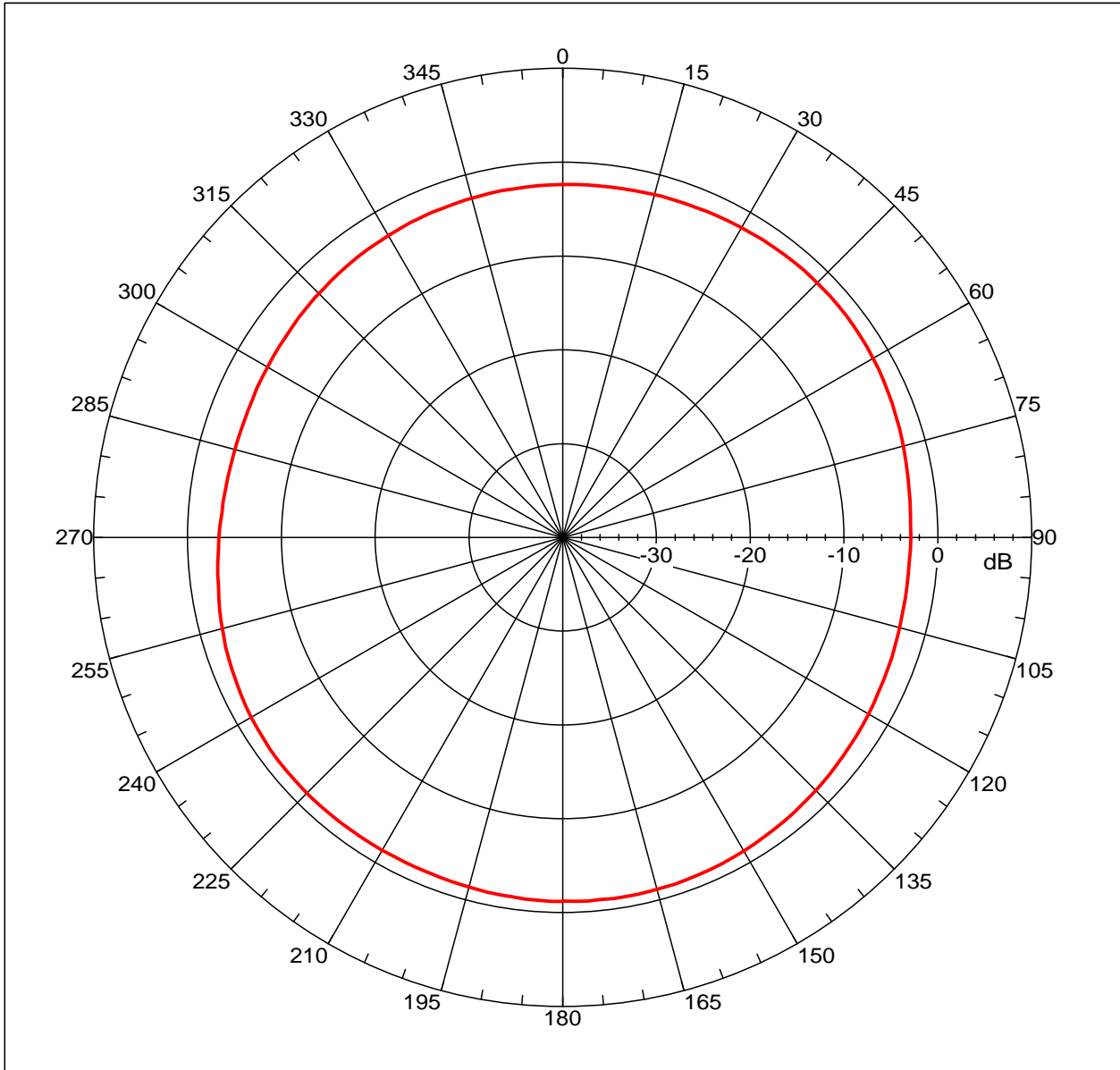

Far-field amplitude, Eprincipal: Linear, Tau = 0.000 deg
 Gain = -1.12514 dBi
 Max far-field (global) = -42.66627 dB, Max far-field (plot) = -42.66628 dB
 Normalization: Reference, Network offset = 0.000 dB
 Hpeak at: 172.000 deg, Vpeak at: 0.000 deg
 Plot centering: On

20101202 MA-83A 900/1800MHZ 3DBI H-PLANE

NSI2000 V4.0.124, Filename:C:\nsi2000\Data\20101202 MA-83A 900-1800MHZ 3DBI H-PLANE0.nsi
 Measurement date/time: 12/2/2010 9:24:36 AM, Filetype: NSI-97

Far-field Cut Analysis:
 Avg value: -2.222 dB
 -3. dB beam width: Not Found
 -6. dB beam width: Not Found
 -10. dB beam width: Not Found
 Left Sidelobe: -0.50 dB at 49.274 deg
 Right Sidelobe: Not Found
 Far-field display setup
 Azimuth (deg)
 Span = 360.00001 deg, Center = 0.000 deg, #pts = 181
 Start = -180.00001 deg, Stop = 180.00001 deg, Delta = 2.000 deg
 Elevation (deg)
 Center = 0.000 deg, #pts = 1

Selected beam(s) 1 of 6

Beam	Frequency	Azimuth	Elevation	Pol
2	0.920 GHz	Azimuth	Elevation	Single-pol

Far-field amplitude of 20101202 MA-83A 900-1800MHZ 3DBI H-PLANE0.nsi

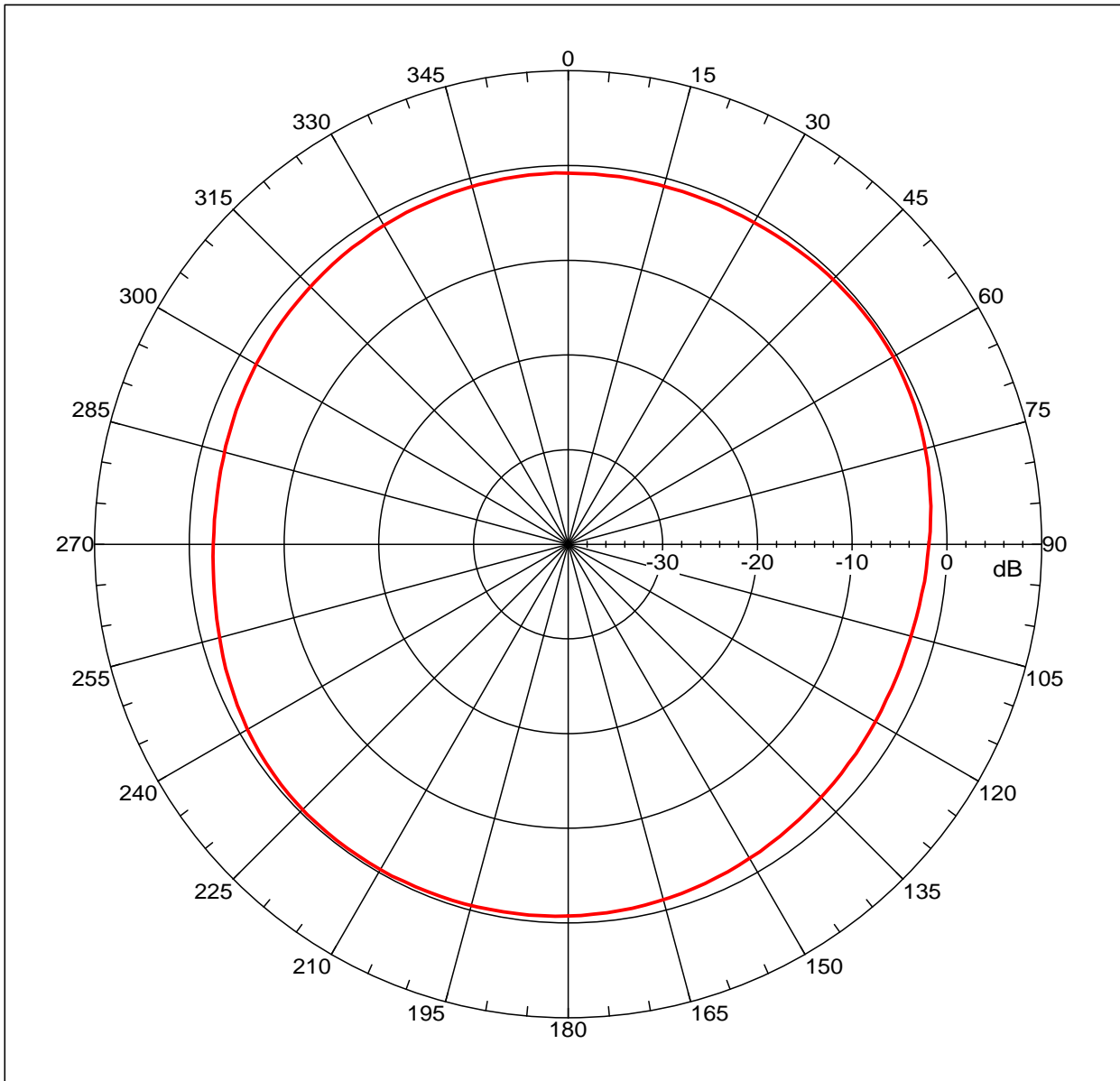

Far-field amplitude, Eprincipal: Linear, Tau = 0.000 deg
 Gain = -0.31999 dBi
 Max far-field (global) = -42.94966 dB, Max far-field (plot) =
 -42.94967 dB
 Normalization: Reference, Network offset = 0.000 dB
 Hpeak at: -144.000 deg, Vpeak at: 0.000 deg
 Plot centering: On

20101202 MA-83A 900/1800MHZ 3DBI H-PLANE

NSI2000 V4.0.124, Filename:C:\nsi2000\Data\20101202 MA-83A
 900-1800MHZ 3DBI H-PLANE0.nsi
 Measurement date/time: 12/2/2010 9:24:36 AM, Filetype: NSI-97

Far-field Cut Analysis:
 Avg value: -1.286 dB
 -3. dB beam width: Not Found
 -6. dB beam width: Not Found
 -10. dB beam width: Not Found
 Left Sidelobe: Not Found
 Right Sidelobe: -0.52 dB at -9.050 deg
 Far-field display setup
 Azimuth (deg)
 Span = 360.00001 deg, Center = 0.000 deg, #pts = 181
 Start = -180.00001 deg, Stop = 180.00001 deg, Delta = 2.000
 deg
 Elevation (deg)
 Center = 0.000 deg, #pts = 1

Selected beam(s) 1 of 6

Beam	Frequency	Azimuth	Elevation	Pol
3	0.960 GHz	Azimuth	Elevation	Single-pol

Far-field amplitude of 20101202 MA-83A 900-1800MHZ 3DBI H-PLANE0.nsi

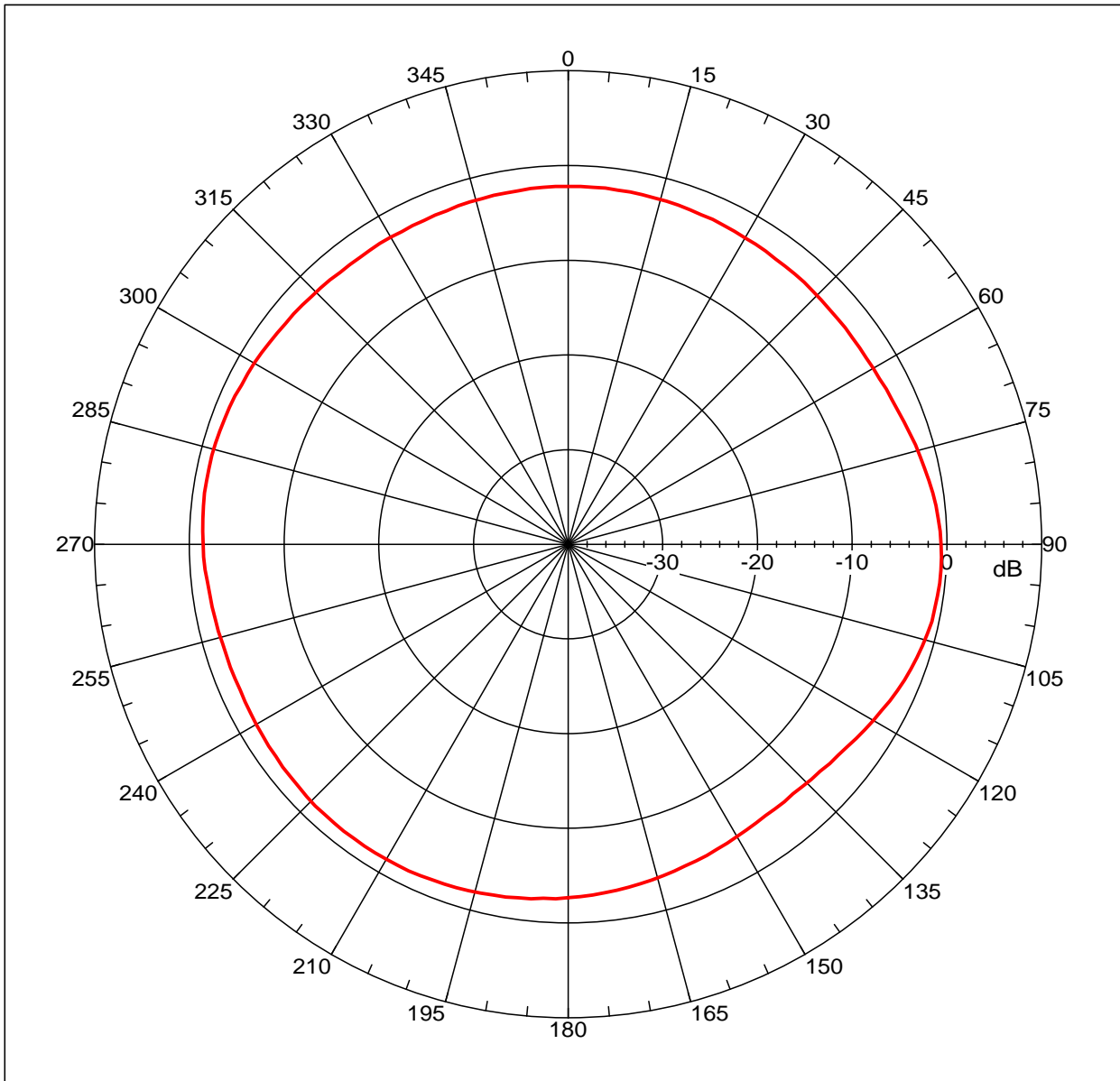

Far-field amplitude, Eprincipal: Linear, Tau = 0.000 deg
 Gain = -0.54979 dBi
 Max far-field (global) = -45.60012 dB, Max far-field (plot) = -45.60013 dB
 Normalization: Reference, Network offset = 0.000 dB
 Hpeak at: 93.99999 deg, Vpeak at: 0.000 deg
 Plot centering: On

20101202 MA-83A 900/1800MHZ 3DBI H-PLANE

NSI2000 V4.0.124, Filename:C:\nsi2000\Data\20101202 MA-83A 900-1800MHZ 3DBI H-PLANE0.nsi
 Measurement date/time: 12/2/2010 9:24:36 AM, Filetype: NSI-97

Far-field Cut Analysis:
 Avg value: -2.252 dB
 -3. dB beam width: Not Found
 -6. dB beam width: Not Found
 -10. dB beam width: Not Found
 Left Sidelobe: -0.71 dB at -75.419 deg
 Right Sidelobe: Not Found
 Far-field display setup
 Azimuth (deg)
 Span = 360.00001 deg, Center = 0.000 deg, #pts = 181
 Start = -180.00001 deg, Stop = 180.00001 deg, Delta = 2.000 deg
 Elevation (deg)
 Center = 0.000 deg, #pts = 1

Selected beam(s) 1 of 6

Beam	Frequency	Azimuth	Elevation	Pol
4	1.710 GHz	Azimuth	Elevation	Single-pol

Far-field amplitude of 20101202 MA-83A 900-1800MHZ 3DBI H-PLANE0.nsi

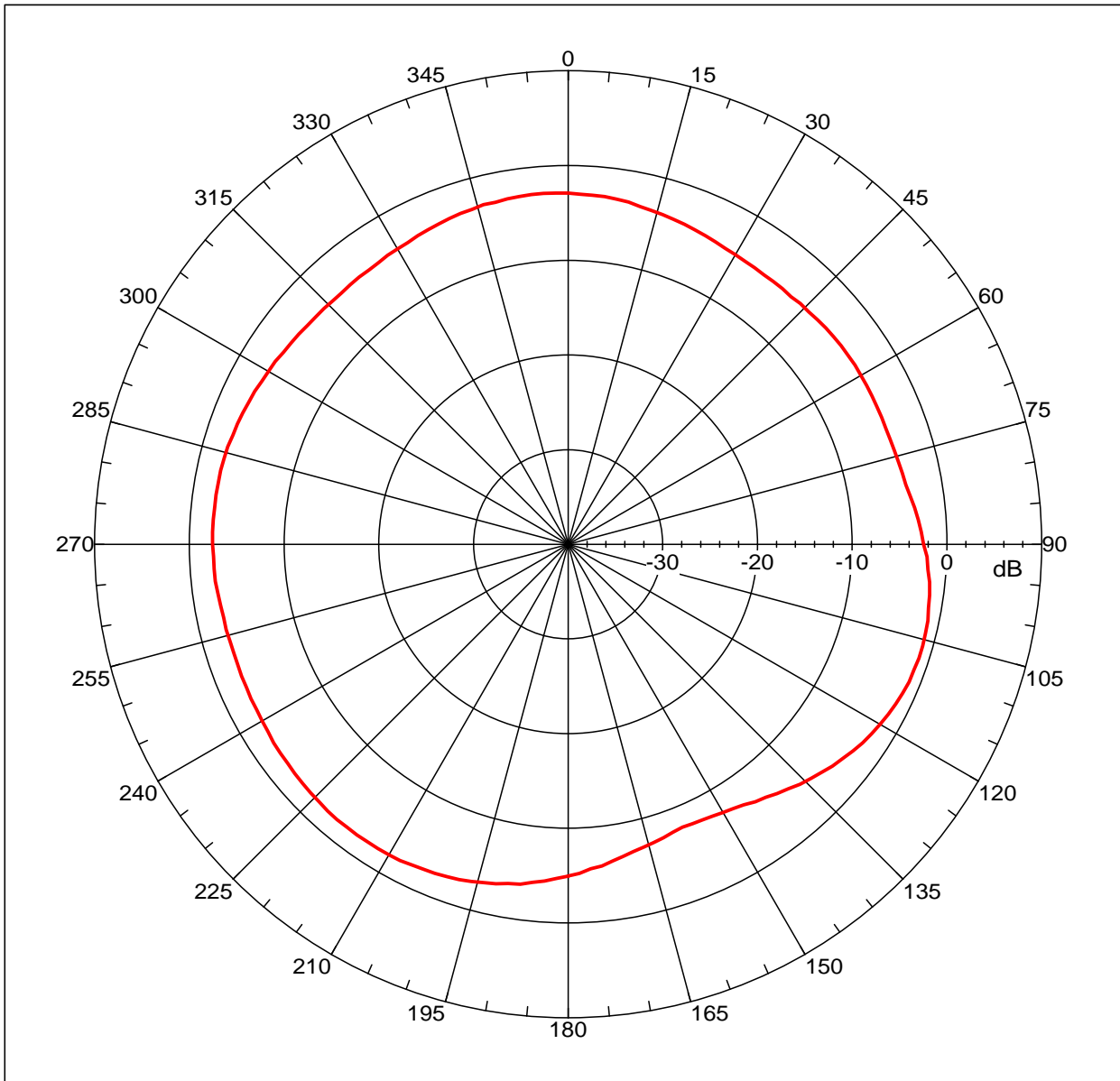

Far-field amplitude, Eprincipal: Linear, Tau = 0.000 deg
 Gain = -1.05531 dBi
 Max far-field (global) = -47.59768 dB, Max far-field (plot) = -47.59769 dB
 Normalization: Reference, Network offset = 0.000 dB
 Hpeak at: 107.99999 deg, Vpeak at: 0.000 deg
 Plot centering: On

20101202 MA-83A 900/1800MHZ 3DBI H-PLANE

NSI2000 V4.0.124, Filename: C:\nsi2000\Data\20101202 MA-83A 900-1800MHZ 3DBI H-PLANE0.nsi
 Measurement date/time: 12/2/2010 9:24:36 AM, Filetype: NSI-97

Far-field Cut Analysis:
 Avg value: -3.501 dB
 -3. dB beam width: 56.51 deg
 -6. dB beam width: Not Found
 -10. dB beam width: Not Found
 Left Sidelobe: -1.81 dB at -3.017 deg
 Right Sidelobe: Not Found
 Far-field display setup
 Azimuth (deg)
 Span = 360.00001 deg, Center = 0.000 deg, #pts = 181
 Start = -180.00001 deg, Stop = 180.00001 deg, Delta = 2.000 deg
 Elevation (deg)
 Center = 0.000 deg, #pts = 1

Selected beam(s) 1 of 6

Beam	Frequency	Azimuth	Elevation	Pol
5	1.800 GHz	Azimuth	Elevation	Single-pol

Far-field amplitude of 20101202 MA-83A 900-1800MHZ 3DBI H-PLANE0.nsi

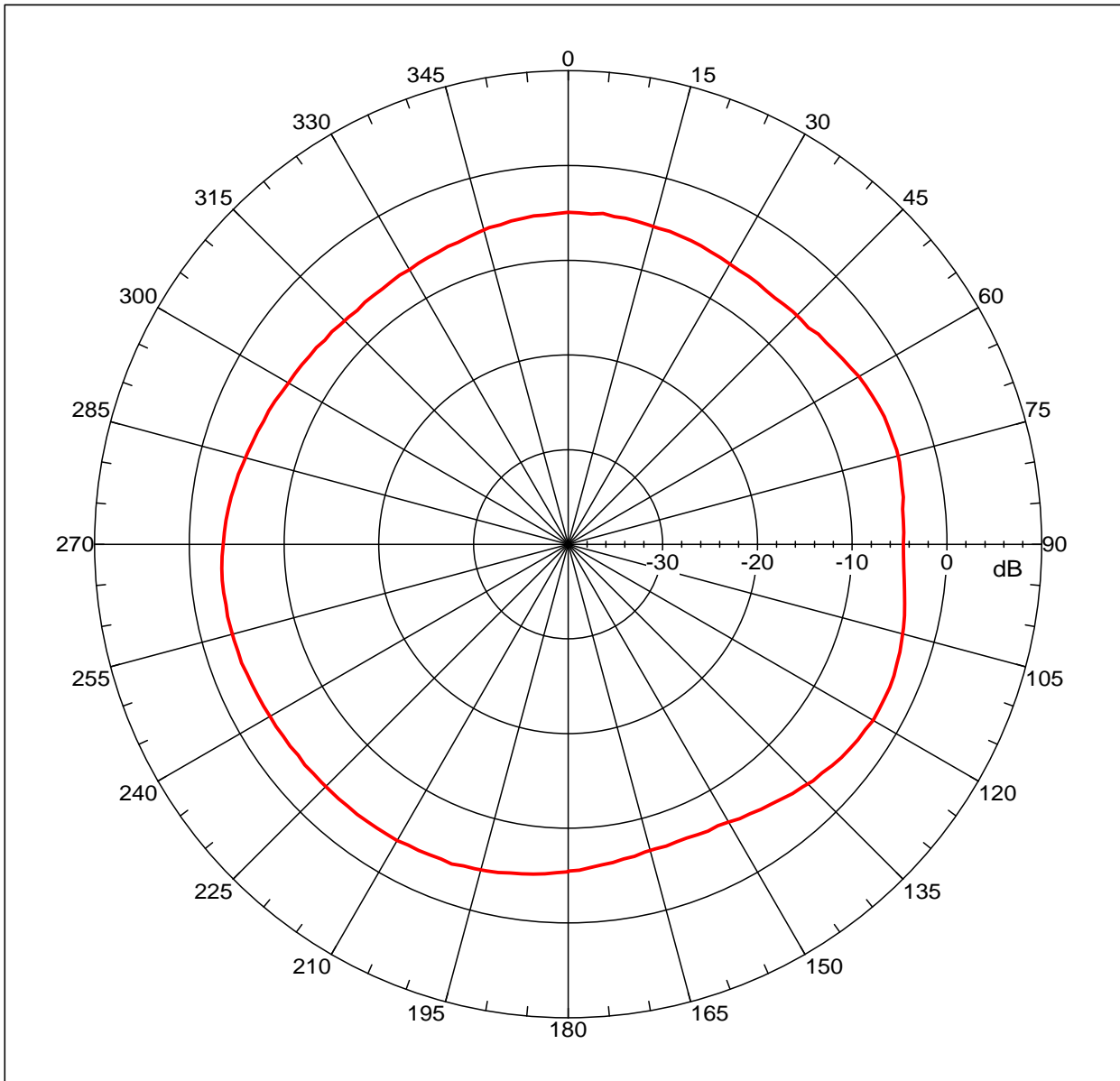

Far-field amplitude, Eprincipal: Linear, Tau = 0.000 deg
 Gain = -2.81113 dBi
 Max far-field (global) = -49.35356 dB, Max far-field (plot) = -49.35357 dB
 Normalization: Reference, Network offset = 0.000 dB
 Hpeak at: 119.99999 deg, Vpeak at: 0.000 deg
 Plot centering: On

20101202 MA-83A 900/1800MHZ 3DBI H-PLANE

NSI2000 V4.0.124, Filename:C:\nsi2000\Data\20101202 MA-83A 900-1800MHZ 3DBI H-PLANE0.nsi
 Measurement date/time: 12/2/2010 9:24:36 AM, Filetype: NSI-97

Far-field Cut Analysis:
 Avg value: -4.752 dB
 -3. dB beam width: 100.10 deg
 -6. dB beam width: Not Found
 -10. dB beam width: Not Found
 Left Sidelobe: -2.08 dB at 7.039 deg
 Right Sidelobe: Not Found
 Far-field display setup
 Azimuth (deg)
 Span = 360.00001 deg, Center = 0.000 deg, #pts = 181
 Start = -180.00001 deg, Stop = 180.00001 deg, Delta = 2.000 deg
 Elevation (deg)
 Center = 0.000 deg, #pts = 1

Selected beam(s) 1 of 6

Beam	Frequency	Azimuth	Elevation	Pol
6	1.880 GHz	Azimuth	Elevation	Single-pol